

APX™ TWO-WAY RADIOS

APX 6000 / APX 6000Li MODEL 2 USER GUIDE





ASTRO® APX™ 6000/APX 6000Li Series

Digital Portable Radios

Quick Reference Card

RF Energy Exposure and Product Safety Guide for Portable Two-Way Radios

ATTENTION!

This radio is restricted to **Occupational use only**. Before using the radio, read the RF Energy Exposure and Product Safety Guide for Portable Two-Way Radios which contains important operating instructions for safe usage and RF energy awareness and control for Compliance with applicable standards and Regulations.

Radio Controls

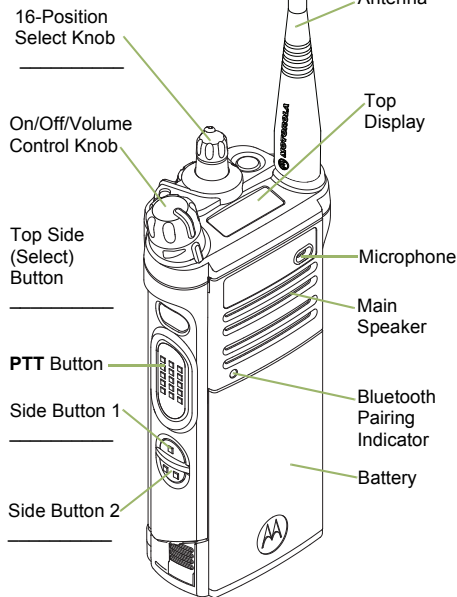
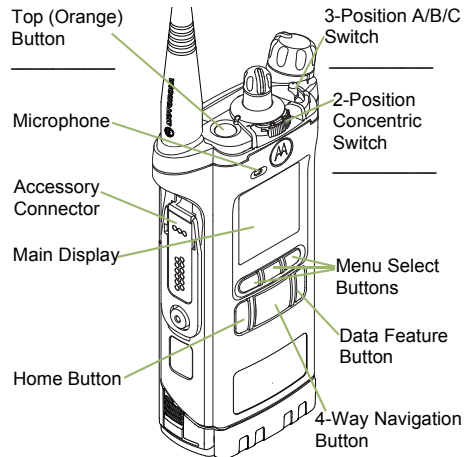

Radio On/Off

- **On** – On/Off/Volume knob clockwise.
- **Off** – On/Off/Volume knob counterclockwise.

Zones and Channels

- **Zone** – Zone switch to desired zone.
- **Channel** – Channel switch to desired channel.

Receiving and Transmitting

- 1 Select zone/channel.
- 2 Listen for a transmission.
OR
Press and hold **Volume Set** button.
OR
Press **Monitor** button and listen for activity.
- 3 Adjust volume, if necessary.

- 4 Press the **PTT** button to transmit; release to receive.

Sending an Emergency Alarm

- 1 Press and hold the **Emergency** button*.
- 2 The display shows **Emergency** and the current zone/channel. You hear a short, medium-pitched tone, and the LED blinks red momentarily.
- 3 When acknowledgment is received, you hear four beeps; alarm ends; and radio exits emergency.

* **Default emergency button press timer is set to 1 second.** This timer is programmable, see page 53 in the user guide for details.

To exit emergency at any time, press and hold the **Emergency** button.



PMLN5716E



English

■ Sending an Emergency Call

- 1 Press the **Emergency** button.
- 2 Press and hold the **PTT** button. Speak clearly into the microphone.
- 3 Release the **PTT** button to end call.
- 4 Press and hold **Emergency** button to exit emergency.



To exit emergency at any time, press and hold the **Emergency** button.







■ Sending a Silent Emergency Call







- 1 Press the **Emergency** button.
- 2 The display does not change; the LED does not light up, and there is no tone.
- 3 Silent emergency continues until you: Press and hold the **Emergency** button to exit emergency state.
OR
Press and release the **PTT** button to exit the Silent Emergency Alarm mode and enter regular dispatch or Emergency Call mode.

To exit emergency at any time, press and hold the **Emergency** button.

■ Display Status Icons

	Receiving a call or data
	Transmitting a call or data

	Blinks when the battery is low.
	The more stripes, the stronger the signal strength for the current site (trunking only).
	Direct radio to radio communication or connected through a repeater. On = Direct Off = Repeater
	This channel is being monitored.
H OR L	L = Radio is set at Low power. H = Radio is set at High power.
	Scanning a scan list.
	Blinking dot = Detects activity on the Priority-One Channel during scan. Steady dot = Detects activity on the Priority-Two Channel during scan.
	The vote scan feature is enabled.

	On = Secure operation. Off = Clear operation. Blinking = Receiving an encrypted voice call.
	On = AES Secure operation. Off = Clear operation. Blinking = Receiving an encrypted voice call.
	On = Location feature enabled, and location signal available. Off = Location feature disabled. Blinking = Location feature enabled, but location signal unavailable.
	On = User is currently associated with the radio. Off = User is currently not associated with the radio. Blinking = Device registration or user registration with the server failed due to an invalid username or pin.
	Data activity is present.
	Bluetooth is ready.
	Bluetooth is connected to the device.

Menu Navigation

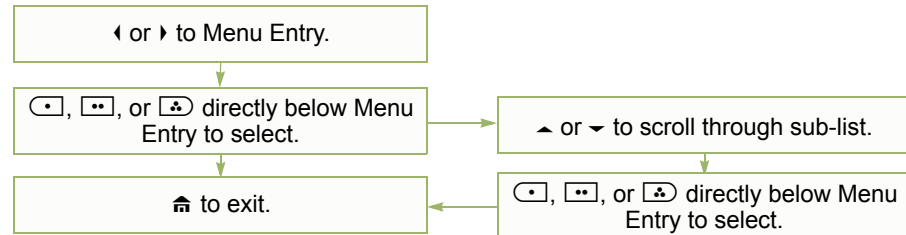

Declaration of Conformity

This declaration is applicable to your radio **only** if your radio is labeled with the FCC logo shown below.

DECLARATION OF CONFORMITY

Per FCC CFR 47 Part 2 Section 2.1077(a)



Responsible Party

Name: Motorola Solutions, Inc.

Address: 1303 East Algonquin Road, Schaumburg, Illinois 60196, U.S.A.

Phone Number: 1-800-927-2744

Hereby declares that the product:

Model Name: **APX 6000/APX 6000Li**

conforms to the following regulations:

FCC Part 15, subpart B, section 15.107(a), 15.107(d) and section 15.109(a)

Class B Digital Device

As a personal computer peripheral, this device complies with Part 15 of the FCC Rules. Operation is subject to the following two conditions:

1. This device may not cause harmful interference, and
2. This device must accept any interference received, including interference that may cause undesired operation.

Note: This equipment has been tested and found to comply with the limits for a Class B digital device, pursuant to part 15 of the FCC Rules. These limits are designed to provide reasonable protection against harmful interference in a residential installation. This equipment generates, uses and can radiate radio frequency energy and, if not installed and used in accordance with the instructions, may cause harmful interference to radio communications. However, there is no guarantee that interference will not occur in a particular installation.

If this equipment does cause harmful interference to radio or television reception, which can be determined by turning the equipment off and on, the user is encouraged to try to correct the interference by one or more of the following measures:

- Reorient or relocate the receiving antenna.
- Increase the separation between the equipment and receiver.
- Connect the equipment into an outlet on a circuit different from that to which the receiver is connected.
- Consult the dealer or an experienced radio/TV technician for help.

Contents

This User Guide contains all the information you need to use the APX™ 6000/APX 6000Li Series Digital Portable Radios.

Declaration of Conformity	i
Important Safety Information	ix
RF Energy Exposure and Product Safety Guide for Portable Two-Way Radios	ix
Software Version	x
Notice to Users (FCC and Industry Canada)	x
Informations importantes sur la sécurité	xi
Exposition aux radiofréquences et sécurité du produit pour radios bidirectionnelles portatives	xi
Version du logiciel	xii
Avis aux utilisateurs (FCC et Industrie Canada)	xii
Computer Software Copyrights	xiii

Documentation Copyrights	xiii
Disclaimer	xiv
Getting Started	1
How to Use This Guide	1
Notations Used in This Manual	1
Additional Performance Enhancement	2
Dynamic System Resilience (DSR)	2
CrossTalk Prevention	2
Encrypted Integrated Data (EID)	2
SecureNet	2
What Your Dealer/System Administrator Can Tell You	3
Preparing Your Radio for Use	3
Charging the Battery	4
Battery Charger	4
Attaching the Battery	4
Attaching the Antenna	5
Attaching the Accessory Connector Cover	6
Using the Carry Holder	6
Turning On the Radio	7

Adjusting the Volume	8
Identifying Radio Controls	9
Radio Parts and Controls	10
Programmable Features	11
Assignable Radio Functions	11
Assignable Settings or Utility Functions	13
Accessing the Preprogrammed Functions	13
Using the Menu Select Buttons	13
Using the Navigation Buttons	14
Home Button	14
Data Feature Button	14
4-Way Navigation Button	14
Push-To-Talk (PTT) Button	14
Identifying Status Indicators	15
Status Icons	15
Text Messaging Service (TMS) Icons	19
Status Icons	19
TMS Menu Options	20
Call Type Icons	21
LED Indicator	22
Intelligent Lighting Indicators	23
Alert Tones	24

Phone Call Display and Alert Prompts	28
General Radio Operation	29
Selecting a Zone	29
Selecting a Radio Channel	30
Receiving and Responding to a Radio Call	31
Receiving and Responding to a Talkgroup Call	32
Receiving and Responding to a Private Call (Trunking Only)	32
Receiving and Responding to a Telephone Call (Trunking Only)	33
Making a Radio Call	34
Making a Talkgroup Call	34
Making a Private Call (Trunking Only)	34
Making an Enhanced Private Call (Trunking Only)	35
Making a Telephone Call (Trunking Only)	36
Repeater or Direct Operation	37
Monitoring Features	37
Monitoring a Channel	37
Conventional Mode Operation	38
Advanced Features	39
Advanced Call Features	39

Receiving and Making a Selective Call (ASTRO Conventional Only)	39	Scan	49
Receiving a Selective Call	39	Turning Scan On or Off	49
Making a Selective Call	40	Making a Dynamic Priority Change (Conventional Scan Only)	50
Using the Talkgroup Call Feature (Conventional Operation Only)	40	Deleting a Nuisance Channel	50
Selecting a Talkgroup	40	Restoring a Nuisance Channel	50
Sending a Status Call	41	Call Alert Paging	51
Using the Dynamic Regrouping Feature (Trunking Only)	42	Receiving a Call Alert Page	51
Requesting a Reprogram (Trunking Only)	42	Sending a Call Alert Page	51
Classifying Regrouped Radios	43	Emergency Operation	53
Using Dynamic Zone Programming (DZP)	43	Sending an Emergency Alarm	53
Entering the Dynamic Zone to Select a Dynamic Channel	43	Sending an Emergency Call (Trunking Only)	54
Saving a Channel in the Dynamic Zone from List Selection	43	Sending an Emergency Alarm with Emergency Call	54
Deleting a Channel in the Dynamic Zone	44	Sending a Silent Emergency Alarm	55
Contacts	44	Using the Emergency Keep-Alive Feature	55
Making a Private Call from Contacts	45	Fireground (Conventional Only)	56
Adding a Contact to a Call List	46	Entering Fireground Zone Channel	56
Removing a Contact from a Call List	46	Responding to Evacuation Indicator	57
Scan Lists	47	Tactical Public Safety (TPS) (Conventional Only) ..	58
Viewing a Scan List	47	Using TPS Normal Transmission	58
Editing the Scan List	47	Man Down	59
Changing the Scan List Status	48	Pre-Alert Timer	60
Viewing and Changing the Priority Status	49	Post-Alert Timer	60
		Alerting User When Man Down Feature is Triggered	60

Triggering Emergency	61	Viewing a Sent Text Message	71
Exiting Man Down Feature	61	Sending a Sent Text Message	72
Re-Initiating Man Down	61	Deleting a Text Message	72
Testing the Man Down Feature	62	Deleting All Text Messages	73
Automatic Registration Service (ARS)	63	Secure Operations	73
Selecting or Changing the ARS Mode	63	Selecting Secure Transmissions	73
Accessing the User Login Feature	64	Selecting Clear Transmissions	74
Logging In as a User	64	Managing Encryption	74
Logging Out	65	Loading an Encryption Key	74
Text Messaging Service (TMS)	65	Using the Multikey Feature	75
Accessing the TMS Features	66	Selecting an Encryption Key	75
Sending a Quick Text Message	66	Selecting a Keyset	76
Using the Priority Status and Request Reply		Erasing the Selected Encryption Keys	76
Features	67	Requesting an Over-the-Air Rekey	
Appending a Priority Status to a Text Message	67	(ASTRO Only)	77
Removing a Priority Status from a Text Message	68	MDC Over-the-Air Rekeying (OTAR) Page	78
Appending a Request Reply to a Text Message	68	Infinite UKEK Retention	78
Removing a Request Reply from a Text Message	68	Hear Clear	78
Appending a Priority Status and a Reply Request		The Global Positioning System (GPS)	79
to a Text Message	68	Understanding the GPS Feature	79
Removing a Priority Status and a Reply Request		Enhancing GPS Performance	80
from a Text Message	69	The Outdoor Location Feature (Using GPS)	80
Managing Text Messages	69	Enabling MGRS Coordinates	80
Receiving a Text Message	69	Accessing the Outdoor Location Feature	81
Viewing a Text Message from the Inbox	70	Saving a Waypoint	82
Replying to a Received Text Message	70	Viewing a Saved Waypoint	82
Managing Sent Text Messages	71	Deleting a Single Saved Waypoint	83

Deleting All Saved Waypoints	83	Viewing and Clearing the Bluetooth Device Information	92
Measuring the Distance and Bearing from a Saved Waypoint	84	Clearing All Bluetooth Devices Information	93
Using the Location Feature While in Emergency Mode	84	Viewing the Bluetooth Friendly Name	94
Trunking System Controls	85	Programming Over Project 25 (POP 25) (ASTRO 25 and ASTRO Conventional)	94
Using the Failsoft System	85	Responding to the notification of Upgrade	95
Going Out of Range	85	Utilities	95
Using the Site Trunking Feature	85	Viewing the Recent Calls	95
Locking and Unlocking a Site	86	Using the Flip Display	96
Viewing and Changing a Site	86	Selecting a Basic Zone Bank	96
Viewing the Current Site	86	Selecting an Enhanced Zone Bank	97
Changing the Current Site	86	Selecting the Power Level	97
Mission Critical Wireless		Selecting a Radio Profile	98
- Bluetooth® -	87	Enabling and Disabling the Radio Alias	98
Turning the Bluetooth On	87	Selecting the Audio Speaker	99
Turning the Bluetooth Off	88	Controlling the Display Backlight	99
Re-Pair Timer	88	Setting Up the Radio Display and Visual Indicators to Suite Night Vision Goggles	100
Bluetooth Drop Timer	89	Locking and Unlocking the Keypad and Controls	101
Pairing Bluetooth Device with the Radio	90	Turning Keypad Tones On or Off	101
Indicating Bluetooth Connection is Lost	91	Turning Voice Mute On or Off	102
Turning On the Bluetooth Audio (Routing the Audio from the Radio to the Headset)	91	Using the Time-Out Timer	102
Turning Off the Bluetooth Audio (Routing the Audio from the Headset to the Radio)	92	Setting the Time and Date	103
Adjusting the Volume of the Radio from Bluetooth Audio Device	92	Editing the Time and Date	103
		Using the Conventional Squelch Operation Features	104

Analog Options	104
Digital Options	104
Using the PL Defeat Feature	105
Using the Digital PTT ID Feature	105
Using the Smart PTT Feature (Conventional Only)	105
IMPRES™ Battery Annunciator	106
Accessing the Battery Info screen	106
Procedure:	106
Accessing the General Radio Information	107
Accessing the Radio Information	108
Viewing the IP Information	109
Viewing the Control Assignments	109
Voice Announcement	110

Helpful Tips111

Caring for Your Radio	111
Cleaning Your Radio	112
Handling Your Radio	113
Servicing Your Radio	113
Taking Care of the Battery	114
Checking the Battery Charge Status	114
LED and Sounds	114
Fuel Gauge Icon	114
Battery Recycling and Disposal	115

Appendix: Maritime Radio Use in the VHF Frequency Range 116

Special Channel Assignments	116
Emergency Channel	116
Non-Commercial Call Channel	116
Operating Frequency Requirements	117
Declaration of Compliance for the User of Distress and Safety Frequencies	119

Accessories 120

Highlights for the Accessories	120
--------------------------------------	-----

Glossary 121

Commercial Warranty 126

Important Safety Information

RF Energy Exposure and Product Safety Guide for Portable Two-Way Radios

ATTENTION!

This radio is restricted to Occupational use only.

Before using the radio, read the RF Energy Exposure and Product Safety Guide for Portable Two-Way Radios which contains important operating instructions for safe usage and RF energy awareness and control for Compliance with applicable standards and Regulations.

For a list of Motorola-approved antennas, batteries, and other accessories, visit the following website:

<http://www.motorolasolutions.com/APX>

Under Industry Canada regulations, this radio transmitter may only operate using an antenna of a type and maximum (or lesser) gain approved for the transmitter by Industry Canada. To reduce potential radio interference to other users, the antenna type and its gain should be so chosen that the equivalent isotropically radiated power

(e.i.r.p.) is not more than that necessary for successful communication.

This radio transmitter has been approved by Industry Canada to operate with the Motorola-approved antenna types with the maximum permissible gain and required antenna impedance for each antenna type indicated. Antenna types not included, having a gain greater than the maximum gain indicated for that type, are strictly prohibited for use with this device.

Software Version

All the features described in the following sections are supported by the radio's software version **R10.00.00** or later.

See ***Accessing the Radio Information*** on page 108 to determine your radio's software version.

Check with your dealer or system administrator for more details of all the features supported.

Notice to Users (FCC and Industry Canada)

This device complies with Part 15 of the FCC rules and RSS 210 of the Industry Canada rules per the conditions listed below:

- 1 This device may not cause harmful interference.
- 2 This device must accept any interference received, including interference that may cause undesired operation.
- 3 Changes or modifications made to this device, not expressly approved by Motorola, could void the user's authority to operate this equipment.

Informations importantes sur la sécurité

Exposition aux radiofréquences et sécurité du produit pour radios bidirectionnelles portatives

ATTENTION!

Cette radio ne doit être utilisée qu'à des fins professionnelles. Avant d'utiliser la radio, lisez le guide Exposition aux radiofréquences et sécurité du produit pour radios bidirectionnelles portatives, qui contient d'importantes instructions de fonctionnement pour une utilisation sécuritaire et des informations sur l'exposition aux fréquences radioélectriques afin d'assurer la conformité aux normes et règlements applicables.

Pour obtenir une liste d'antennes et d'autres accessoires approuvés par Motorola, consultez le site Web:
<http://www.motorolasolutions.com/APX>

Selon la réglementation d'Industrie Canada, cet émetteur radio ne peut être utilisé qu'avec une antenne dont le type et le gain maximal (ou minimal) sont approuvés par Industrie Canada pour cet émetteur. Afin de limiter les interférences radio pour les

autres utilisateurs, le type et le gain de l'antenne doivent être choisis de façon à ce que la puissance isotrope rayonnée équivalente (P.I.R.E.) ne soit pas plus forte qu'il ne le faut pour établir la communication.

Le présent émetteur a été approuvé par Industrie Canada pour fonctionner avec les types d'antenne agréés par Motorola et ayant un gain admissible maximal ainsi que l'impédance requise pour chaque type d'antenne indiqué. Les types d'antenne non inclus, dont le gain est supérieur au gain maximal indiqué, sont strictement interdits pour l'exploitation de l'émetteur.

Version du logiciel

Toutes les fonctionnalités décrites dans les sections suivantes sont prises en charge par la version du logiciel **R10.00.00** ou ultérieure de la radio.

Vérifiez auprès de votre détaillant ou de l'administrateur de système pour obtenir des renseignements sur les fonctionnalités prises en charge.

Avis aux utilisateurs (FCC et Industrie Canada)

Cet appareil est conforme à la Partie 15 des règlements de la FCC et RSS 210 du règlement d'Industrie Canada selon les conditions énumérées ci-dessous:

- 1 Ce dispositif ne doit pas causer d'interférences nuisibles.
- 2 Cet appareil doit accepter toute interférence reçue, y compris les interférences qui peuvent perturber le fonctionnement.
- 3 Les changements ou les modifications apportées à ce dispositif, non expressément approuvées par Motorola, peuvent annuler le droit de l'utilisateur à utiliser cet équipement.

Computer Software Copyrights

The Motorola products described in this manual may include copyrighted Motorola computer programs stored in semiconductor memories or other media. Laws in the United States and other countries preserve for Motorola certain exclusive rights for copyrighted computer programs, including, but not limited to, the exclusive right to copy or reproduce in any form the copyrighted computer program. Accordingly, any copyrighted Motorola computer programs contained in the Motorola products described in this manual may not be copied, reproduced, modified, reverse-engineered, or distributed in any manner without the express written permission of Motorola. Furthermore, the purchase of Motorola products shall not be deemed to grant either directly or by implication, estoppel, or otherwise, any license under the copyrights, patents or patent applications of Motorola, except for the normal non-exclusive license to use that arises by operation of law in the sale of a product.

Documentation Copyrights

No duplication or distribution of this document or any portion thereof shall take place without the express written permission of Motorola. No part of this manual may be reproduced, distributed, or transmitted in any form or by any means, electronic or mechanical, for any purpose without the express written permission of Motorola.

Disclaimer

The information in this document is carefully examined, and is believed to be entirely reliable. However, no responsibility is assumed for inaccuracies. Furthermore, Motorola reserves the right to make changes to any products herein to improve readability, function, or design. Motorola does not assume any liability arising out of the applications or use of any product or circuit described herein; nor does it cover any license under its patent rights, nor the rights of others.

Getting Started

Take a moment to review the following:

How to Use This Guide	page 1
Notations Used in This Manual	page 1
Additional Performance Enhancement	page 2
What Your Dealer/System Administrator Can Tell You	page 3

How to Use This Guide

This User Guide covers the basic operation of the APX™ 6000/APX 6000Li Portables.

However, your dealer or system administrator may have customized your radio for your specific needs. Check with your dealer or system administrator for more information.

Notations Used in This Manual

Throughout the text in this publication, you will notice the use of **WARNING**, **Caution**, and **Note**. These notations are used to emphasize that safety hazards exist, and the care that must be taken or observed.





An operational procedure, practice, or condition, etc., which may result in injury or death if not carefully observed.



An operational procedure, practice, or condition, etc., which may result in damage to the equipment if not carefully observed.

Note: An operational procedure, practice, or condition, etc., which is essential to emphasize.

The following special notations identify certain items:

Example	Description
Home button or 	Buttons and keys are shown in bold print or as an icon.
Phone	Menu entries are shown similar to the way they appear on the radio's display.
	This means "Press the right side of the 4-way Navigation button".

■ Additional Performance Enhancement

The following are some of the latest creations designed to enhance the security, quality and efficiency of APX radios.

Dynamic System Resilience (DSR)

DSR ensures the radio system is seamlessly switched to a backup master site dynamically in case of system failure. DSR also provides additional indication e.g. failure detection, fault recovery, and redundancy within the system to address to the user in need. Mechanisms related to the Integrated Voice and Data (IV & D) or data centric are all supported by DSR.

CrossTalk Prevention

This feature prevents crosstalk scenario from happening, especially when a wideband antenna is used. This feature allows the adjustment of the Trident Transmitting SSI clock rate in the radio to be varied from the Receiving Frequency. This subsequently reduced the possibilities of radio frequency interfering spurs and prevents the issues of crosstalk.

Encrypted Integrated Data (EID)

EID provides security encryption and authentication of IV & D data bearer service communication between the radio and the Customer Enterprise Network.

SecureNet

SecureNet allows user to perform secured communications on an Analog or Motorola Data Communication (MDC) channel. The MDC OTAR feature will allow users to perform OTAR activities on an MDC channel.

■ What Your Dealer/System Administrator Can Tell You

Check with your dealer or system administrator for the correct radio settings, if the radio is to be operated in extreme temperatures (less than -30 °C or more than +60 °C), to ensure proper top and front display operation.

You can also consult your dealer or system administrator about the following:

- Is your radio preprogrammed with any preset conventional channels?
- Which buttons have been preprogrammed to access other features?
- What optional accessories may suit your needs?

Preparing Your Radio for Use

Assemble your radio by following these steps:

- Charging the Battery page 4
 - Battery Charger page 4
- Attaching the Battery page 4
- Attaching the Antenna page 5
- Attaching the Accessory Connector Cover page 6
- Using the Carry Holder. page 6
- Turning On the Radio page 7
- Adjusting the Volume page 8

■ Charging the Battery



WARNING

To avoid a possible explosion:

- **DO NOT** replace the battery in any area labeled “hazardous atmosphere”.
- **DO NOT** discard batteries in a fire.

The Motorola-approved battery shipped with your radio is uncharged. Prior to using a new battery, charge it for a minimum of 16 hours to ensure optimum capacity and performance.

For a list of Motorola-authorized batteries available for use with your radio, see **Accessories** on page 120.

Note: When charging a battery attached to a radio, turn the radio off to ensure a full charge.

Battery Charger

To charge the battery, place the battery, with or without the radio, in a Motorola-approved charger. The charger's LED indicates the charging progress; see your charger's user guide.

For a list of chargers, see **Accessories** on page 120.

■ Attaching the Battery

With the radio turned off, slide the battery into the radio's frame until side latches click into place.

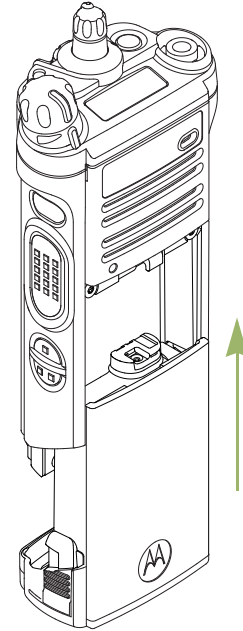

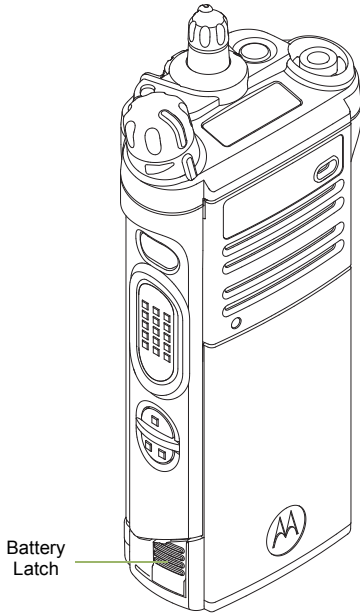

To remove the battery, turn the radio off. Squeeze the release latches at the bottom of the battery until the battery releases from the radio. Remove the battery from the radio.

Note: If your radio is preprogrammed with volatile-key retention, the encryption keys are retained for approximately 30 seconds after battery removal. Check with your dealer or system administrator for more information.

You can view the status of the IMPRES™ battery if the radio is using an IMPRES battery. See **IMPRES™ Battery Annunciator** on page 106 for more information.

■ Attaching the Antenna

With the radio turned off, set the antenna in its receptacle and turn clockwise to attach it to the radio.

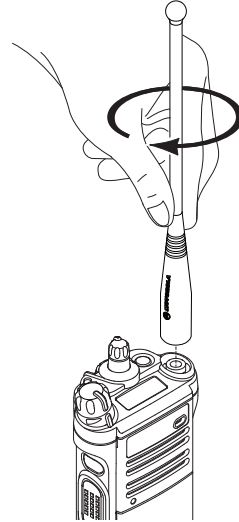

To remove the antenna, turn the antenna counterclockwise. Make sure you turn off the radio first.

■ Attaching the Accessory Connector Cover

The accessory connector is located on the antenna side of the radio. It is used to connect accessories to the radio.

Note: To prevent damage to the connector, shield it with the connector cover when not in use.

Insert the hooked end of the cover into the slot above the connector. Press downward on the cover's top to seat it in the slot. Once in place, tighten by rotating the thumbscrew clockwise by hand.

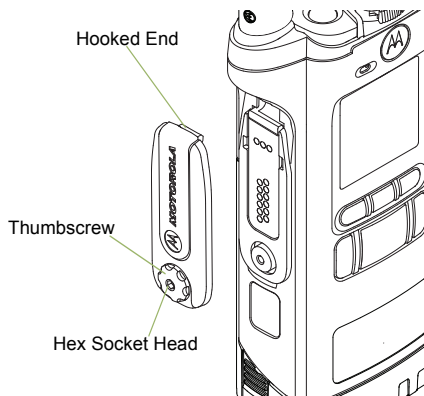

To remove the accessory connector cover, rotate the thumbscrew counterclockwise until it disengages from the radio. If the thumbscrew is too tight, use an Allen wrench to loosen it first.

Rotate and lift the connector cover to disengage it from the radio.

■ Using the Carry Holder

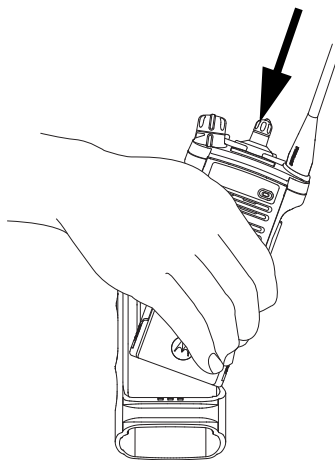

Position the radio within the carry holder with the main speaker facing outward. Slide the radio down into the carry holder until it clicks in place.

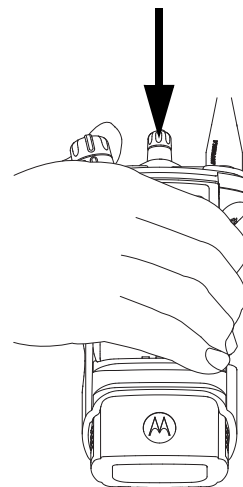

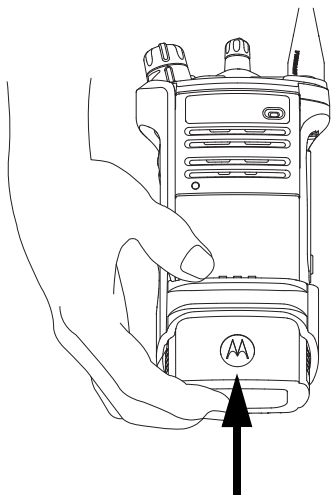

To remove the radio from the carry holder, place the tip of your fingers on the ledge of the carry holder and push at the bottom of the radio until the radio is released from it.

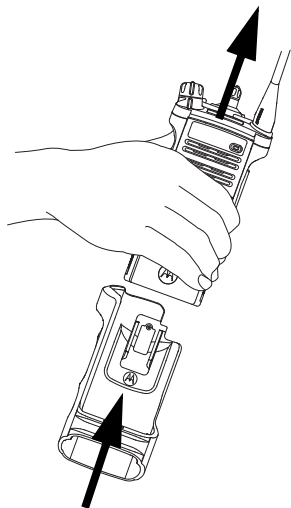

■ Turning On the Radio

Rotate the **On/Off/Volume Control Knob** clockwise until you hear a click.

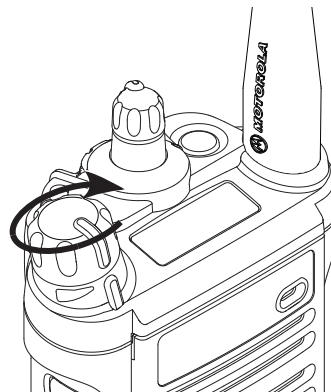

If the power-up test is successful, you see momentary **SELFTEST** on the radio's display, followed by the Home screen.

Note: If the power-up test is unsuccessful, you see **Error XX/YY** (**XX/YY** is an alphanumeric code).

Turn off your radio, check the battery, and turn the radio back on. If the radio fails the power-up test again, record the **Error XX/YY** code and contact your dealer.

Note: If the power-up test is successful, but you see **Hardware board absent** or **Hw Board Mismatch**. Send your radio to the qualified technician to fix this error.

If the power-up test is successful, but you see **Hw Board Failed** or **Man-Down Hw Error**, send your radio to the qualified technician to fix this error.

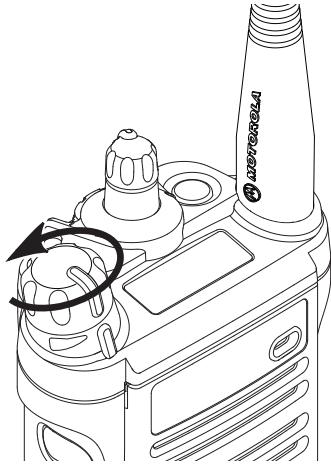

To turn off the radio, rotate the **On/Off/Volume Control Knob** counterclockwise until you hear a click.

■ Adjusting the Volume

To increase the volume, turn the **On/Off/Volume Control Knob** clockwise.

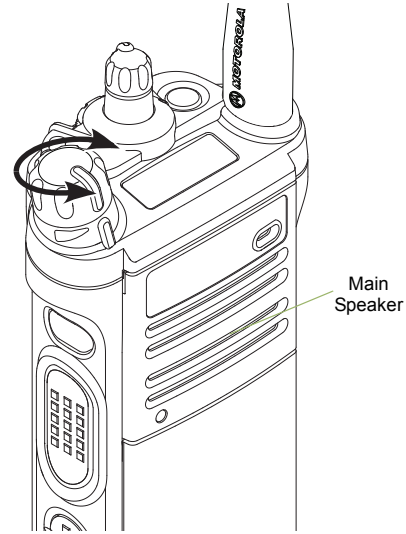

To decrease the volume, turn this knob counterclockwise.

Note: Ensure that the main speaker is pointed towards you for increased loudness and intelligibility, especially in areas with loud background noises.

Identifying Radio Controls

Take a moment to review the following:

Radio Parts and Controls	page 10
Programmable Features	page 11
Assignable Radio Functions	page 11
Assignable Settings or Utility Functions.	page 13
Accessing the Preprogrammed Functions.	page 13
Using the Menu Select Buttons	page 13
Using the Navigation Buttons.	page 14
Push-To-Talk (PTT) Button	page 14

Radio Parts and Controls

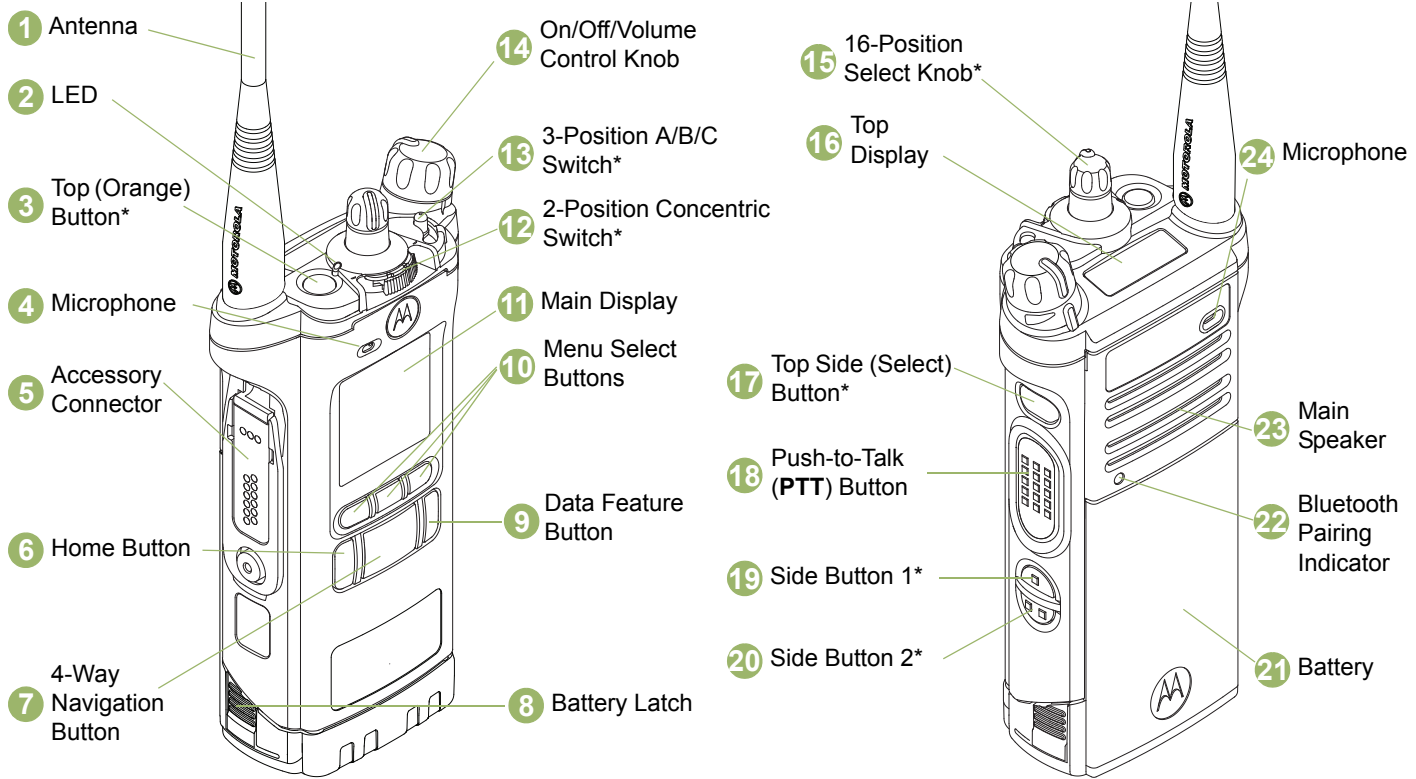

* These radio controls/buttons are programmable.

■ Programmable Features

Any reference in this manual to a control that is “preprogrammed” means that the control must be programmed by a dealer or qualified radio technician using the radio’s programming software, in order to assign a feature to that control.

The programmable buttons can be programmed as shortcuts to radio functions or preset channels/groups depending on the duration of a button press:

- **Press** – Pressing and releasing rapidly.
- **Long press** – Pressing and holding for the preprogrammed duration (between 0.25 seconds and 3.75 seconds).
- **Hold down** – Keeping the button pressed.

Assignable Radio Functions

Bluetooth On/Off – Allows you to turn on/off the Bluetooth.

Bluetooth Configuration – Allows you to access to the Bluetooth menu.

Bluetooth Audio Reroute – Allows you to toggle the audio route between radio speaker or Remote Speaker Microphone and Bluetooth headset.

Bluetooth Headset and PTT – Keys up the Bluetooth Headset’s microphone.

Bluetooth Data Devices – Keys up the Bluetooth data devices.

Bluetooth Clear All Pairing – Allows you to clear all pairing information for Bluetooth. This is accessed by a long press of the Bluetooth On/Off Button.

Call Alert – Allows the radio to function like a pager, or to verify if a radio is active on the system.

Call Response – Allows you to answer a private call.

Channel – Selects a channel.

Contacts – Selects the Contacts menu.

Dynamic Priority (Conventional Only) – Allows any channel in a scan list (except for the Priority-One channel) to temporarily replace the Priority-Two channel.

Emergency – Depending on the programming, initiates or cancels an emergency alarm or call.

Information – Displays the information of the radio.

Internet Protocol Address – Displays the Internet Protocol (IP) address, device name and status of the radio.

Location – Determines the current location (latitude, longitude, time and date), and also the distance and bearing to another location. Or, turns the GPS functionality on or off for all location.

Man Down – Prompts Emergency Alarm or Call when the radio achieves or passes a tilt angle threshold or a combination of the angle threshold and a motion sensitivity level.

Message – Enters the current message list.

Monitor (Conventional Only) – Monitors a selected channel for all radio traffic until function is disabled.

Multiple Private Line (Conventional Only) – Selects the Multiple Private Line lists.

Nuisance Delete – Temporarily removes an unwanted channel, except for priority channels or the designated transmit channel, from the scan list.

One Touch 1 – 4 – Launches a specific feature with one single button-press. You can setup as many as four separately programmed buttons for four different features.

Phone – Allows you to make and receive calls similar to standard phone calls.

Private Call (Trunking Only) – Allows a call from an individual radio to another individual radio.

Private Line Defeat (Conventional Only) – Overrides any coded squelch (DPL or PL) that is preprogrammed to a channel.

Radio Profiles – Allows for easy access to a set of preprogrammed visual and audio settings of the radio.

Recent Calls – Allows for easy access to the list of calls recently received or made.

Rekey Request – Notifies the dispatcher you want a new encryption keys.

Repeater Access Button (RAB) (Conventional Only) – Allows to manually send a repeater access codeword.

Reprogram Request (Trunking Only) – Notifies the dispatcher you want a new dynamic regrouping assignment.

Request-To-Talk (Conventional Only) – Notifies the dispatcher you want to send a voice call.

Scan – Toggles scan on or off.

Selective Call (Conventional Only) – Calls an assigned radio.

Site Display/Search (Trunking Only) – Displays the current site ID and RSSI value; performs site search for AMSS (Automatic Multiple Site Select) or SmartZone operation.

Site Lock/Unlock (Trunking Only) – Locks onto a specific site.

Status – Sends data calls to the dispatcher about a predefined status.

Talkaround/Direct (Conventional Only) – Toggles between using a repeater and communicating directly with another radio.

Talkgroup (Conventional Only) – Allows a call from an individual radio to a group of radios.

Text Messaging Service (TMS) – Selects the text messaging menu.

TMS Quick Text – Selects a predefined message.

User – Automatically registers with the server.

Zone Select – Allows selection from a list of zones.

Basic Zone Bank – Provides access from up to 6 zones by toggling between 2 banks of 3 zones, one group of 3 (A, B and C) to a second group of 3 zones (D, E and F).

Enhanced Zone Bank – Provides access from up to 75 zones by toggling between 25 banks (A, B ... X or Y) of 3 zones.

Assignable Settings or Utility Functions

Light/Flip – Press the button to toggle the display backlight on or off; press and hold the button to reverse the content of the top display.

Keypad and Controls Lock – Locks or unlocks the keypad, programmable buttons, switches and rotary knobs.

Voice Announcement – Audibly indicates the current feature mode, Zone or Channel the user has just assigned.

Voice Mute – Toggles voice mute on or off.

Volume Set Tone – Sets the volume set tone.

Accessing the Preprogrammed Functions

You can access various radio functions through one of the following ways:

- A short or long press of the relevant programmable buttons.

OR

- Use the **Menu Select Buttons** (, , and ).

Using the Menu Select Buttons

The **Menu Select** buttons access the menu entries of features.

Note: Check with your dealer or system administrator for the list of features activated in your radio.

Your radio may be preprogrammed differently from the following example, but the steps for selecting a channel may appear as shown below:

- Press the **Menu Select** button () directly below **Chan**.

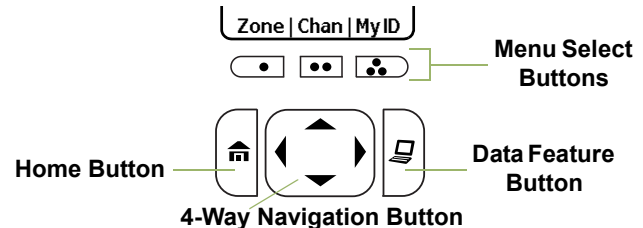

Using the Navigation Buttons

Home Button

The  button returns you to the Home (default) screen. In most cases, this is the current mode.

For selected radio features, the  button is also used to save user-edited radio settings or information before returning you to the Home screen.

Note: Some features do not require you to press  to go to the Home screen. Refer to the individual feature sections in this manual for further details on saving user-edited radio settings or information.

Data Feature Button

Use this button to access data-related features, such as the Text Messaging Service (TMS) feature screen.

4-Way Navigation Button

Use this button to scroll up, down, left or right.

Press and release one of the button to scroll from one entry to the next one. Press and hold one of the button to have your radio toggles through the list automatically (release the button to stop).

Push-To-Talk (PTT) Button

The **PTT** button on the side of your radio serves two basic purposes :

- While a call is in progress, the **PTT** button allows your radio to transmit to other radios in the call.

Press and hold down **PTT** button to talk. Release the **PTT** button to listen.

The microphone is activated when the **PTT** button is pressed.

- While a call is not in progress, the **PTT** button is used to make a new call. See **Making a Radio Call** on page 34 for more information.

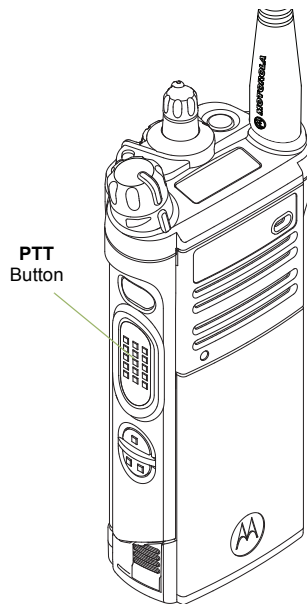

PTT Button

Identifying Status Indicators

Your radio indicates its operational status through the following:

Status Icons	page 15
Text Messaging Service (TMS) Icons	page 19
Status Icons	page 19
TMS Menu Options	page 20
Call Type Icons	page 21
LED Indicator	page 22
Intelligent Lighting Indicators	page 23
Alert Tones	page 24
Phone Call Display and Alert Prompts	page 28

■ Status Icons

The 130 x 130 pixel front liquid crystal display (LCD) of your radio shows radio status, text entries, and menu entries. The top two display rows contain color icons that indicate radio operating conditions.

Selected icons are also shown on the first row of the 112 x 32 pixel top monochrome display screen of your radio.

The following icons are for the front display screen unless indicated otherwise.



Receiving
Radio is receiving a call or data.

Top Display



Transmitting
Radio is transmitting a call or data.

Top Display



Call Received
Radio has received an Individual Call.



Battery
For IMPRES battery operation only – the icon shown indicates the charge remaining in the battery.

Top Display



For all battery operation – the icon blinks when the battery is low.



Received Signal Strength Indicator (RSSI)

The number of bars displayed represents the received signal strength for the current site, for trunking only. The more stripes in the icon, the stronger the signal.



Roaming

The radio has roamed to and is currently registered to a foreign system.



Direct

- **On** = Radio is currently configured for direct radio-to-radio communication (during conventional operation only).
- **Off** = Radio is connected with other radios through a repeater.



Monitor (Carrier Squelch)

Selected channel is being monitored (during conventional operation only).



In-Call User Alert

- **On** = The feature is enabled. Voice muting of the affiliated trunking talkgroup or selected conventional channel is activated.
- **Off** = The feature is disabled. Voice muting of the affiliated trunking talkgroup or selected conventional channel is deactivated.

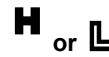

Power Level

- **L** = Radio is set at Low power.

Top Display

- **H** = Radio is set at High power.

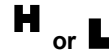

Scan

Radio is scanning a scan list.

Top Display





Top Display

Priority Channel Scan

- **Blinking dot** = Radio detects activity on channel designated as Priority-One.
- **Steady dot** = Radio detects activity on channel designated as Priority-Two.

Top Display



View/Program Mode

Radio is in the view or program mode.

- **On steady** = View mode
- **Blinking** = Program mode



Top Display



Vote Scan Enabled

The vote scan feature is enabled.

Top Display

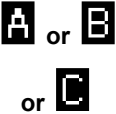

Basic Zone Bank 1

- **A** = Radio is in Zone 1.
- **B** = Radio is in Zone 2.
- **C** = Radio is in Zone 3.

Top Display

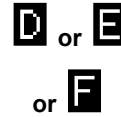

Basic Zone Bank 2

- **D** = Radio is in Zone 4.
- **E** = Radio is in Zone 5.
- **F** = Radio is in Zone 6.

Top Display



Enhanced Zone Bank

- A** = Contains Zone 1, Zone 2 and Zone 3,
- B** = Contains Zone 4, Zone 5 and Zone 6,
- C** = Contains Zone 7, Zone 8 and Zone 9,
- X** = Contains Zone 70, Zone 71 and Zone 72,
- Y** = Contains Zone 73, Zone 74 and Zone 75.

Top Display



Secure Operation

- **On** = Secure operation.
- **Off** = Clear operation.
- **Blinking** = Receiving an encrypted voice call.



AES Secure Operation

- **On** = AES Secure operation.
- **Off** = Clear operation.
- **Blinking** = Receiving an encrypted voice call.

Location Signal



- **On** = Location feature is enabled, and location signal is available.
- **Off** = Location feature is disabled.
- **Blinking** = Location feature is enabled, but no location signal is available.

User Login Indicator (IP Packet Data)



- **On** = User is currently associated with the radio.
- **Off** = User is currently not associated with the radio.
- **Blinking** = Device registration or user registration with the server failed due to an invalid username or pin.



- **Inverted** = User successfully login to the secured IP Packet Data.



Data Activity

Data activity is present.



Bluetooth On

Bluetooth is on and ready for bluetooth connection.

Top Display



Bluetooth Connected

Bluetooth is currently connected to the external bluetooth device.

Top Display



■ Text Messaging Service (TMS) Icons

This feature allows you to send and receive text messages. See *Text Messaging Service (TMS)* on page 65 for more information.

📄 Status Icons

The following icons appear on the radio's display when you send and receive text messages.



Inbox Full

The Inbox is full.



Message Sent

The text message is sent successfully.



Message Unsent

The text message cannot be sent.

Unread Message



- User receives a new message.
- The selected text message in the Inbox has not been read.



Read Message

The selected text message in the Inbox has been read.



Normal Message

User is composing a message with normal priority and without a request for a reply.

3/6

Message Index

Indicates the index of the current message the user is viewing.

Example: If the user is looking at the third message out of a total of 6 messages in the Inbox folder, the icon is displayed as the icon on the left column.



Priority Status

- The "Priority" feature is toggled on before the message is sent.
- Messages in the Inbox folder are flagged with "Priority".



Request Reply



- The “Request Reply” feature is toggled on before the message is sent.



- Messages in the Inbox folder are flagged with “Request Reply”.

Priority Status and Request Reply



- User is composing a message with a priority status and a request for a reply.
- Messages in the Inbox folder are flagged with “Priority” and “Request Reply”.

TMS Menu Options

Menu Option	Description/Function
Back	Brings you back to the previous screen.
Clr	Deletes all messages.
Del	Deletes a message.
Exit	Exits to the Home screen.
No	Returns to the previous screen.
Optn	Brings you to the Options main screen.
Rply	Replies to a message.
Sel	Selects the highlighted command.
Send	Sends the message.
Yes	Updates or saves a command.

■ Call Type Icons

The following icons appear on your radio's main display, when you make or receive a call, or view selected call lists, to indicate the different call types associated with an alias or ID.



Radio number.



Radio number added to a Call List.



Mobile number.



Mobile number added to a Call List.



Landline phone number.



Landline phone number added to a Call List.



Incoming call or data.



Outgoing call or data.



Incoming emergency call.

■ LED Indicator

The LED indicator shows the operational status of your radio.

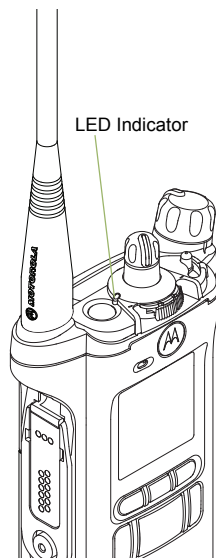

Solid red – Radio is transmitting.

Blinking red – Radio is transmitting at low battery condition.

Rapidly blinking red – Radio has failed the self test upon powering up or encountered a fatal error.

Solid yellow (Conventional Only) – Channel is busy.

Blinking yellow – Radio is receiving a secured transmission.

Solid green – Radio is powering up, or is on a non-priority channel while in the Scan List Programming mode.

Blinking green – Radio is receiving an individual or telephone call, or is on a Priority-Two channel while in the Scan List Programming mode.

Rapidly blinking green – Radio is on a Priority-One channel while in the Scan List Programming mode.

Note: No LED indication when the radio receives a clear (non-secured) transmission in trunking Mode.

■ Intelligent Lighting Indicators

This feature temporarily changes the backlight of the top display screen, and adds a color bar to the main display screen to help signal that a radio event has occurred.

Note: This feature must be preprogrammed by a qualified radio technician.

Backlight and Bar Color	Notification	When
Orange	Emergency Alerts	The radio initiates an emergency alarm or call.
		The radio receives an emergency alarm or call.
Red	Critical Alerts	The radio battery is low.
		The radio is out of range.
		The radio enters failsoft mode.
		The radio is unable to establish a full connection with the system.
		The radio is unable to authenticate or register with the system.
Green	Call Alerts	The radio receives a private call.
		The radio receives a phone call.
		The radio receives a call alert.
		The radio receives a selective call.

■ Alert Tones

Your radio uses alert tones to inform you of your radio's condition. The following table lists these tones and when they occur.

You Hear	Tone Name	Heard
Short, Low-Pitched Tone	Radio Self Test Fail	When radio fails its power-up self test.
	Reject	When an unauthorized request is made.
	Time-Out Timer Warning	Four seconds before time out.
	No ACK Received	When radio fails to receive an acknowledgment.
	Individual Call Warning Tone	When radio is in an individual call for greater than 6 seconds without any activity.
	Man Down Entry	When radio initiates Man Down mode.
Long, Low-Pitched Tone	Time-Out Timer Timed Out	After time out.
	Talk Prohibit/PTT Inhibit	(When PTT button is pressed) transmissions are not allowed.
	Out of Range	(When PTT button is pressed) the radio is out of range of the system.
	Invalid Mode	When radio is on an unprogrammed channel.
A Group of Low-Pitched Tones	Busy	When system is busy.



You Hear	Tone Name	Heard
Short, Medium-Pitched Tone	Valid Key-Press	When avcorrect key is pressed.
	Radio Self Test Pass	When radio passes its power-up self test.
	Clear Voice	At beginning of a non-coded communication.
	Priority Channel Received	When activity on a priority channel is received.
	Emergency Alarm /Call Entry	When entering the emergency state.
	Central Echo	When central controller has received a request from a radio.
Long, Medium-Pitched Tone	Volume Set	When volume is changed on a quiet channel.
	Emergency Exit	When exiting the emergency state.
A Group of Medium-Pitched Tones	Failsoft	When the trunking system fails.
	Automatic Call Back	When voice channel is available from previous request.
	Keyfail	When encryption key has been lost.
	Console Acknowledge	When status, emergency alarm, or reprogram request ACK is received.
	Received Individual Call	When Call Alert or Private Call is received.
	Call Alert Sent	When Call Alert is received by the target radio.
	Site Trunking	When a SmartZone trunking system fails.

You Hear	Tone Name	Heard
Short, High-Pitched Tone (Chirp)	Low-Battery Chirp	When battery is below preset threshold value.
Ringling	Fast Ringing	When system is searching for target of Private Call.
	Enhanced Call Sent	When waiting for target of Private Call to answer the call.
	Phone Call Received	When a land-to-mobile phone call is received.
Gurgle	Dynamic Regrouping	(When PTT button is pressed) a dynamic ID has been received.
	Talk Permit	(When PTT button is pressed) verifying system accepting transmissions.
Unique, Low-Pitched Chirp	New Message	When a new message is received.
Unique, High-Pitched Chirp	Priority Status	When a priority message is received.
Incremental-Pitched Tone	Bluetooth Paired	When Bluetooth accessory is paired with the radio.
	Bluetooth Connected	When Bluetooth accessory is connected to the radio.
Decremental-Pitched Tone	Bluetooth Unpaired	When Bluetooth accessory is unpaired from the radio.
	Bluetooth Disconnected	When Bluetooth accessory is disconnected from the radio.
A Group of Very High-Pitched Tones	Man Down Continuous Tone	When radio is in Man Down mode and prepares to transmit Emergency Alarm when the timer of this alarm ends.

You Hear	Tone Name	Heard
Doh-Sol	Enhanced Zone Bank Up	When EZB Up button is pressed to scroll the Enhance Zone Bank up.
Sol-Doh	Enhanced Zone Bank Down	When EZB Down button is pressed to scroll the Enhance Zone Bank down.

■ Phone Call Display and Alert Prompts

The following appears on the radio's display when you make and receive Phone calls. The radio also uses alert tones to indicate the current status.

You Hear	You See	When	Notes
A Long Tone	No phone	You press the PTT button and the phone system is not available.	Press  to hang up. The radio returns to the Home screen.
	Phone busy	The phone system is busy.	Press  to exit the phone mode and try your call later.
A Busy Tone	Phone busy	When a channel is not available.	The radio automatically connects when a channel opens.
-	No acknowledge	The call is not acknowledged.	Press  to hang up. The radio returns to the Home screen.
A High-Pitched Tone	-	When you release the PTT button.	The radio indicates to the landline party that he or she may begin talking.

General Radio Operation

Once you understand how your APX 6000/APX 6000Li Portable is configured, you are ready to use your radio.

Use this navigation guide to familiarize yourself with the basic Call features:

Selecting a Zone	page 29
Selecting a Radio Channel	page 30
Receiving and Responding to a Radio Call	page 31
Making a Radio Call	page 34
Repeater or Direct Operation	page 37
Monitoring Features	page 37

Selecting a Zone

A zone is a group of channels.

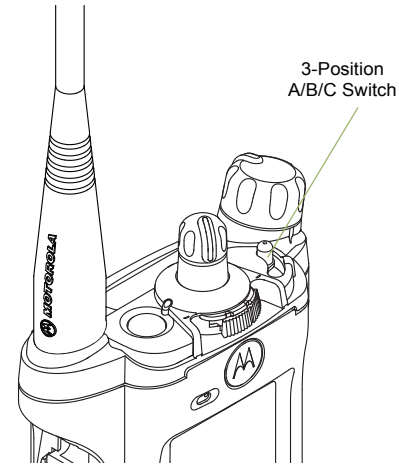

Use the following procedure to select a zone.

Note: Your radio must be preprogrammed to allow you to use this feature.

Procedure:

Move the preprogrammed **Zone (3-Position A/B/C)** switch to the position of the required zone and proceed to Step 3.

OR

Follow the procedure below.

- 1 ◀ or ▶ to **Zone**.
- 2 Press the **Menu Select** button directly below **Zone**.
- 3 ▲ or ▼ to the required zone.
- 4 Press the **Menu Select** button directly below **Sel** to confirm the displayed zone.
- 5 Press the **PTT** button to transmit on the displayed zone channel.

OR

Follow the procedure below.

- 1 ◀ or ▶ to **ZnUp** or **ZnDn**.
- 2 Press and hold the **Menu Select** button directly below **ZnUp** or **ZnDn** until the required zone appears.

Note: Positions of **ZnUp** and **ZnDn** on the display may differ each time you release the **Menu Select** button. Read carefully before you press.

■ Selecting a Radio Channel

A channel is a group of radio characteristics, such as transmit/receive frequency pairs.

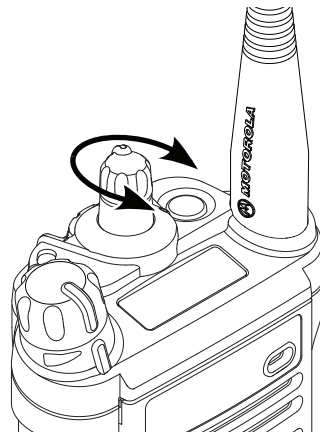

Use the following procedure to select a channel.

Note: Your radio must be preprogrammed to allow you to use this feature. If you select a channel that is not within the preprogrammed band, the radio indicates that it is on an unsupported frequency with both audio and visual warnings.

Consult a qualified radio technician for the right choice between the following methods.

Procedure:

Turn the preprogrammed **16-Position Select Knob** to the desired channel.

OR

Follow the procedure below.

- 1 ◀ or ▶ to **Chan.**
- 2 Press the **Menu Select** button directly below **Chan.**
- 3 ▲ or ▼ to the required channel.
- 4 Press the **Menu Select** button directly below **Sel** to confirm the selected channel.
- 5 Press the **PTT** button to transmit on the displayed zone channel.

OR

Follow the procedure below.

- 1 ◀ or ▶ to **ChUp** or **ChDn.**
- 2 Press the **Menu Select** button directly below **ChUp** or **ChDn.**
- 3 Press the **PTT** button to transmit on the displayed zone and channel.

Note: Positions of **ChUp** and **ChDn** on the display may differ each time you release the **Menu Select** button. Read carefully before you press.

■ Receiving and Responding to a Radio Call

Once you have selected the required channel and/or zone, you can proceed to receive and respond to calls.

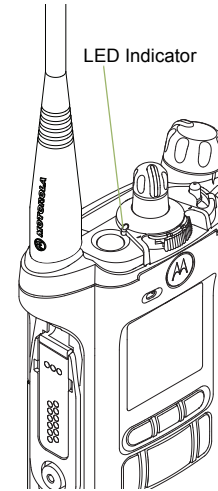

The LED lights up solid red while the radio is transmitting. In conventional mode, the LED lights up solid yellow when the radio is receiving a transmission. In trunking mode, there is no LED indication when the radio receives a transmission.

If the radio is receiving a secure transmission, the LED blinks yellow.

Receiving and Responding to a Talkgroup Call

To receive a call from a group of users, your radio must be configured as part of that talkgroup.

Procedure:

When you receive a talkgroup call (while on the Home screen), depending on how your radio is preprogrammed:

1 **ASTRO Conventional Only:**

The LED lights up solid yellow. The display shows the talkgroup alias or ID, and the caller alias or ID.

OR

Trunking Only:

The display shows the caller alias or ID.

2 Hold the radio vertically 1 to 2 inches (2.5 to 5.0 cm) from your mouth.

3 Press the **PTT** button to respond to the call. The LED lights up solid red.

4 Release the **PTT** button to listen.

See ***Making a Talkgroup Call*** on page 34 for details on making a Talkgroup Call.

Receiving and Responding to a Private Call (Trunking Only)

A Private Call is a call from an individual radio to another individual radio.

These one-to-one calls between two radios are not heard by others in the current talkgroup. The calling radio automatically verifies that the receiving radio is active on the system and can display the caller ID.

Note: The radio automatically exits the feature, if the feature inactivity timer is enabled, when the radio is left idle and the timer expires. You will hear the Menu Inactive Exit Tone upon feature exit.

Procedure:

When you receive a Private Call:

1 You hear two alert tones and the LED blinks green. The display shows **Call received** and the call received icon blinks.

2 Press the **Menu Select** button directly below **Resp.**

OR

Press the **Call Response** button within 20 seconds after the call indicators begin.

3 During the call, the display shows the caller alias (name), if it is in the call list.

OR

During the call, the display shows the caller ID (number), if the caller's name is not in the call list.

- 4 Press and hold the **PTT** button to talk. Release the **PTT** button to listen.
- 5 Press  or the **Call Response** button to hang up and return to the Home screen.

See **Making a Private Call (Trunking Only)** on page 34 for details on making a Private Call.

Receiving and Responding to a Telephone Call (Trunking Only)

This feature allows you to receive calls similar to standard phone calls from a landline phone.

Note: The radio automatically exits the feature, if the feature inactivity timer is enabled, when the radio is left idle and the timer expires. You will hear the Menu Inactive Exit Tone upon feature exit.

Procedure:

Use the preprogrammed **Call Response** button to answer a Telephone Call:

- 1 You hear a telephone-type ringing and the LED blinks green. The backlight of the screen and the bar turns green. The display shows **Phone Call** and the call received icon blinks.
- 2 Press the **Call Response** button within 20 seconds after the call indicators begin.
- 3 Press and hold the **PTT** button to talk. Release the **PTT** button to listen.
- 4 Press  or the **Call Response** button to hang up and return to the Home screen.

See **Making a Telephone Call (Trunking Only)** on page 36 for details on making a Telephone Call.

■ Making a Radio Call

You can select a zone, channel, subscriber ID, or talkgroup by using:

- The preprogrammed Zone switch
- The 16-Position Select Channel Knob
- A preprogrammed **One Touch Call** button
- The Contacts list

Note: The radio automatically exits the feature, if the feature inactivity timer is enabled, when the radio is left idle and the timer expires. You will hear the Menu Inactive Exit Tone upon feature exit.

Making a Talkgroup Call

To make a call to a group of users, your radio must be configured as part of that talkgroup.

Procedure:

- 1 Turn the 16-Position Select Channel Knob to select the channel with the desired talkgroup.
 - 2 Hold the radio vertically 1 to 2 inches (2.5 to 5.0 cm) from your mouth.
 - 3 Press the **PTT** button to make the call.
-

4 **ASTRO Conventional Only:**

The LED lights up solid red. The display shows the talkgroup alias or ID.

OR

Trunking Only:

The LED lights up solid red.

5 Speak clearly into the microphone.

6 Release the **PTT** button to listen.

Making a Private Call (Trunking Only)

Procedure:

Press the preprogrammed **Quick Access (One-Touch) Private Call** button to dial the preprogrammed ID (number) and proceed to Step 5.

OR

Follow the procedure below.

- 1 **◀** or **▶** to **Call**.
 - 2 Press the **Menu Select** button directly below **Call**. The display shows the last transmitted or received ID.
 - 3 Press the **Menu Select** button directly below **Cnts** to scroll through and select the required ID.
- OR**
Press the **Menu Select** button directly below **LNum** to go to the last number dialed.

OR

▲ or ▼ to the required ID.

- 4 Press the **PTT** button to start the Private Call.
 - 5 The display shows **Calling... <Number>**.
 - 6 Hold the radio vertically 1 to 2 inches (2.5 to 5.0 cm) from your mouth.
 - 7 When you are connected, the display shows the ID of the target radio. Press and hold the **PTT** button to talk. Release the **PTT** button to listen.
- OR**
If no acknowledgment is received, the display shows **No acknowledge**.
- 8 Press  to return to the Home screen.

Making an Enhanced Private Call (Trunking Only)

This feature allows you to send an individual Call Alert page if there is no answer from the target radio. See **Sending a Call Alert Page** on page 51 for more information.



Note: Your radio must be preprogrammed to allow you to use this feature.

Procedure:

Press the preprogrammed **Quick Access (One-Touch) Enhanced Private Call** button to dial the preprogrammed ID and proceed to Step 5.

OR

Follow the procedure below.

- 1  or  to **Call**.
 - 2 Press the **Menu Select** button directly below **Call**. The display shows the last transmitted or received ID.
 - 3 Press the **Menu Select** button directly below **Cnts** to scroll through and select the required ID.
- OR**
Press the **Menu Select** button directly below **LNum** to go to the last number dialed.
- OR**
▲ or ▼ to the required ID.
- 4 Press the **PTT** button to start the Private Call.
 - 5 The display shows **Calling... <Number>**.

- 6 Hold the radio vertically 1 to 2 inches (2.5 to 5.0 cm) from your mouth.
- 7 When you are connected, the display shows the ID of the target radio. Press and hold the **PTT** button to talk. Release the **PTT** button to listen.
OR
If no acknowledgment is received, the display shows **No acknowledge**.
OR
If the target radio does not respond before the time out, the display shows **No answer**.
- 8 Press  to return to the Home screen.

Making a Telephone Call (Trunking Only)

This feature allows you to make calls similar to standard phone calls to a mobile or landline phone.



Procedure:

Press the preprogrammed **Quick Access (One-Touch) Phone Call** button to dial the preprogrammed phone number and proceed to Step 5.

OR

Follow the procedure below.

- 1  or  to **Phon**.
- 2 Press the **Menu Select** button directly below **Phon**. The display shows the last transmitted phone number.

- 3 Press the **Menu Select** button directly below **Cnts** to scroll through and select the required ID.
OR
Press the **Menu Select** button directly below **LNum** to go to the last number dialed.
OR
 or  to the required phone number.
- 4 Press and release the **PTT** button to dial the phone number.
- 5 Hold the radio vertically 1 to 2 inches (2.5 to 5.0 cm) from your mouth.
- 6 When your call is answered, press the **PTT** button to talk. Release the **PTT** button to listen.
- 7 Press  to return to the Home screen.

See **Phone Call Display and Alert Prompts** on page 28 for more information if your call is **NOT** answered.

■ Repeater or Direct Operation

The **REPEATER** operation increases the radio's range by connecting with other radios through a repeater. The transmit and receive frequencies are different.

The **DIRECT** or "talkaround operation" allows you to bypass the repeater and connect directly to another radio. The transmit and receive frequencies are the same.

Procedure:

Press the preprogrammed **Repeater/Direct** switch to toggle between talkaround and repeater modes.

OR

Follow the procedure below.

- 1 ◀ or ▶ to **Dir**.
 - 2 Press the **Menu Select** button directly below **Dir**.
 - 3 The display shows **Repeater mode** if the radio is currently in Repeater mode.
OR
The display shows **Direct mode** and the Talkaround icon if the radio is currently in Direct mode (during conventional operation only).
-

■ Monitoring Features

Radio users who switch from analog to digital radios often assume that the lack of static on a digital channel is an indication that the radio is not working properly. This is not the case.

This digital technology quiets the transmission by removing the "noise" from the signal and allows only the clear voice or data information to be heard.

Use the Monitor feature to make sure a channel is clear before transmitting.

Monitoring a Channel

Procedure:

Use the preprogrammed **Volume Set** button.

- 1 Select the desired zone and channel.
 - 2 Press and hold the **Volume Set** button to hear the volume set tone.
 - 3 Adjust the **Volume Control Knob** if necessary.
 - 4 Release the **Volume Set** button.
 - 5 Press and hold the **PTT** button to transmit. The LED lights up solid red.
-

6 Release the **PTT** button to receive (listen).

OR

Press the preprogrammed **Monitor** button and proceed to Step 3.

OR

Follow the procedure below.

- 1 Select the desired zone and channel.

- 2 Listen for a transmission.

- 3 Adjust the **Volume Control Knob** if necessary.

- 4 Press and hold the **PTT** button to transmit. The LED lights up solid red.

- 5 Release the **PTT** button to receive (listen).

*The Carrier Squelch indicator appears on the display when you monitor a channel via the preprogrammed **Monitor** button.*

Conventional Mode Operation

Your radio may be preprogrammed to receive Private-Line® (PL) calls.

Procedure:

- 1 Momentarily press the **Monitor** button to listen for activity. The Carrier Squelch indicator appears on the display.

- 2 Press and hold the **Monitor** button to set continuous monitor operation. The duration of the button press is programmable.

- 3 Press the **Monitor** button again, or the **PTT** button, to return to the original squelch setting.

*If you try to transmit on a receive-only channel, you hear an invalid tone until you release the **PTT** button.*

Advanced Features

Use this navigation guide to learn more about advanced features available with your radio:

Advanced Call Features	page 39
Contacts	page 44
Scan Lists	page 47
Scan	page 49
Call Alert Paging	page 51
Emergency Operation	page 53
Fireground (Conventional Only)	page 56
Tactical Public Safety(TPS) (Conventional Only)	page 58
Man Down	page 59
Automatic Registration Service (ARS).	page 63
Text Messaging Service (TMS)	page 65
Secure Operations.	page 73
The Global Positioning System (GPS)	page 79
Trunking System Controls	page 85
Mission Critical Wireless - Bluetooth® -	page 87
Programming Over Project 25 (POP 25) (ASTRO 25 and ASTRO Conventional)	page 94
Utilities	page 95

Advanced Call Features

Receiving and Making a Selective Call (ASTRO Conventional Only)

This feature allows you to receive a call from or to call a specific individual. It is intended to provide privacy and to eliminate the annoyance of having to listen to conversations that are of no interest to you.

Receiving a Selective Call

Procedure:

- When you receive a Selective Call, the call received icons blinks and the display shows **Call received**. You hear two alert tones, the LED lights up solid yellow to indicate the transmitting radio is still sending signal.
OR
the LED blinks solid green once to indicate the transmitting radio is pending to receive signal.
- The speaker unmutes.
- Hold the radio vertically 1 to 2 inches (2.5 to 5.0 cm) from your mouth.
- Press and hold the **PTT** button to talk. Release the **PTT** button to listen.





Making a Selective Call

Procedure:

Press the preprogrammed **Quick Access (One-Touch) Selective Call** button to dial the preprogrammed ID and proceed to Step 4.

OR

Follow the procedure below.

- 1  or  to **Call**.
- 2 Press the **Menu Select** button directly below **Call**. The display shows the last transmitted or received ID.
- 3 Press the **Menu Select** button directly below **Cnts** to scroll through and select the required ID.
OR
Press the **Menu Select** button directly below **LNum** to go to the last number dialed.
OR
 or  to the required ID.
OR
Use the keypad to enter the required ID.
- 4 Hold the radio vertically 1 to 2 inches (2.5 to 5.0 cm) from your mouth.
- 5 Press and hold the **PTT** button to start the Selective Call. The display shows the ID of the target radio.

- 6 Release the **PTT** button to listen.

- 7 Press  to hang up and return to the Home screen.







Using the Talkgroup Call Feature (Conventional Operation Only)

This feature allows you to define a group of conventional system users so that they can share the use of a conventional channel.

Note: Encryption keys are associated to talkgroups. When talkgroups are associated, encryption keys are changed by changing the active talkgroup. See **Secure Operations** on page 73 for more information.

Selecting a Talkgroup

Procedure:

- 1  or  to **Tgrp**.
- 2 Press the **Menu Select** button directly below **Tgrp**. The display shows the last talkgroup that was selected and stored, **Sel** and **Exit**.
- 3  or  to **Preset** for the preset preprogrammed talkgroup.
OR
 or  to the required talkgroup.
- 4 Press the **Menu Select** button directly below **Sel** to save the currently selected talkgroup and return to the Home screen.

- 5 If the encryption key associated to the new talkgroup is erased, you hear a momentary key fail tone and the display shows **Key fail**.

OR

If the encryption key that is associated to the new talkgroup is not allowed, you hear a momentary key fail tone and the display shows **Illegal key**.

- 6 Press  to return to the Home screen.

Sending a Status Call

This feature allows you to send data calls to the dispatcher about a predefined status.

Each status can have up to a 14-character name. A maximum of sixteen status conditions is possible.

Note: The radio automatically exits the feature, if the feature inactivity timer is enabled, when the radio is left idle and the timer expires. You will hear the Menu Inactive Exit Tone upon feature exit.

Procedure:

Press the preprogrammed **Status** button and proceed to Step 3.



OR

Follow the procedure below.

- 1  or  to **Sts**.

- 2 Press the **Menu Select** button directly below **Sts**.

- 3 The display shows the last acknowledged status call, or the first status in the list.

- 4  or  to the required status.

OR

Use the keypad to enter a number corresponding to the location in the status list.

- 5 Press the **PTT** button to send the status.

- 6 When the dispatcher acknowledges, you hear four tones and the display shows **Ack received**. The radio returns to normal dispatch operation.

OR

If no acknowledgment is received, you hear a low-pitched tone and the display shows **No acknowledge**.

- 7 Press  to return to the Home screen.

*No traffic is heard on trunked channels while Status Call is selected. If the radio detects no Status Call activity for six seconds, you will an alert tone until you press  or the **PTT** button.*

Using the Dynamic Regrouping Feature (Trunking Only)

This feature allows the dispatcher to temporarily reassign selected radios to a particular channel where they can communicate with each other. This feature is typically used during special operations and is enabled by a qualified radio technician.

You will not notice whether your radio has this feature enabled until a dynamic regrouping command is sent by the dispatcher.

Note: If you try to access a zone or channel that has been reserved by the dispatcher as a dynamically regrouped mode for other users, you will hear an invalid tone.

Procedure:

- 1 When your radio is dynamically regrouped, it automatically switches to the dynamically regrouped channel. You hear a “gurgle” tone and the display shows the dynamically regrouped channel’s name.
- 2 Press the **PTT** button to talk. Release **PTT** button to listen.

When the dispatcher cancels dynamic regrouping, the radio automatically returns to the zone and channel that you were using before the radio was dynamically regrouped.

Requesting a Reprogram (Trunking Only)



This feature allows you to notify the dispatcher when you want a new dynamic regrouping assignment.

Procedure:

Press the preprogrammed **Reprogram Request** button to send reprogram request to the dispatcher and proceed to Step 3.

OR

Follow the procedure below.

- 1  or  to **Rpgm**.
- 2 Press the **Menu Select** button directly below **Rpgm** to send reprogram request to the dispatcher.
- 3 The display shows **Reprgrm rqst** and **Please wait**.
- 4 If you hear four beeps, the dispatcher has acknowledged the reprogram request. The display shows **Ack received** and the radio returns to the Home screen.
OR
If the dispatcher does not acknowledge the reprogram request within six seconds, you hear a low-pitched alert tone and the display shows **No acknowledge**.
Try again or press  to cancel and return to the Home screen.

Classifying Regrouped Radios

The dispatcher can classify regrouped radios into either of two categories: **Select Enabled** or **Select Disabled**.

- Select-enabled radios are free to change to any available channel, including the dynamic-regrouping channel, once the user has selected the dynamic-regrouping position.
- Select-disabled radios cannot change channels while dynamically regrouped. The dispatcher has forced the radio to remain on the dynamic-regrouping channel.

The Scan or Private Call feature cannot be selected while your radio is Select Disabled.

Using Dynamic Zone Programming (DZP)

Note: Your radio must be preprogrammed to allow you to use this feature.
This feature works on the condition at least one zone in the radio must be a non-dynamic zone.

This feature provides one or more Dynamic Zones to store the frequent used channels be it conventional or trunking. These dynamic channels are saved from pre-existing (non-dynamic) channels in the radio. This saves the time and effort from the regular navigation around the working zones and channels. User can also delete or update the list in the Dynamic Zone.

Entering the Dynamic Zone to Select a Dynamic Channel

Procedure:

- 1 **◀ or ▶ to Zone.**
- 2 Press the **Menu Select** button directly below **Zone**. The display shows the Zone screen.
- 3 **▲ or ▼ to <Dynamic Zone Channels>.**
- 4 Press the **Menu Select** button below **Sel**. The display returns to Home screen with the selected **<Dynamic Zone Channels>** shown on the screen.
OR
Press the **Menu Select** button below **Exit**. The display returns to Home screen without any changes.

Saving a Channel in the Dynamic Zone from List Selection

With the radio in Dynamic Zone, follow the procedure below.

Procedure:

- 1 **◀ or ▶ to ZnPr**. Press the **Menu Select** button directly below **ZnPr** to enter **Program Zone** screen.
- 2 Press the **Menu Select** button directly below **Edit**. The display shows **Search Options** screen.
- 3 **▲ or ▼ to List Selecton**. Press the **Menu Select** button directly below **Sel**. The display shows **Select Zone** screen.

- 4 ▲ or ▼ to the required zone. Press the **Menu Select** button directly below **Sel**. The display shows **Select Chan** screen.
- 5 ▲ or ▼ to the required channel. Press the **Menu Select** button directly below **Sel**. The display shows **Channel updated**.
- 6 Press the **Menu Select** button directly below **Exit** to return to Home screen.

Deleting a Channel in the Dynamic Zone

With the radio in Dynamic Zone, follow the procedure below.

Procedure:

- 1 ◀ or ▶ to **ZnPr**. Press the **Menu Select** button directly below **ZnPr** to enter **Program Zone** screen.
- 2 The display shows the dynamic channels list.
- 3 ▲ or ▼ to the saved dynamic channel. Press the **Menu Select** button directly below **Del**. The display shows **Channel deleted**.
- 4 Press the **Menu Select** button below **Exit** to return to **Home** screen.
- 5 The **Home** screen shows **<Dynamic Zone Channels>**.
OR
The **Home** screen shows **<Zone Name>+“Blank”** if the channel deleted is the Home channel.

■ **Contacts**

This feature provides “address-book” capabilities on your radio. Each entry corresponds to an alias (name) or ID (number) that you use to initiate a call.

Contact entries are alphabetically sorted according to entry alias. Each alias can have up to five IDs of different call types associated with it.

Additionally, each entry, depending on context (conventional, trunking, or phone), associates with one or more of the four types of calls: Phone Call, Selective Call, Private Call, or Call Alert.

Each entry within Contacts displays the following information:

- Call Alias (Name)
- Call ID (Number)
- Call Type (Icon)
- WACN ID (Astro 25 Trunking IDs only)
- System ID

Note: Your radio must be preprogrammed to allow you to add, edit, or delete the contact entries.

Your radio also supports a maximum of 50 call lists. Each list can store up to 100 IDs (numbers).

Note: Your radio is preprogrammed with a number of contacts per Call Lists. Check with your dealer or system administrator for more information.

The radio automatically exits the feature, if the feature inactivity timer is enabled, when the radio is left idle and the timer expires. You will hear the Menu Inactive Exit Tone upon feature exit.

Making a Private Call from Contacts



Note: Your radio must be preprogrammed to allow you to use this feature.

Procedure:



Use the Options Menu.



- 1  or  to **Cnts**.

- 2 Press the **Menu Select** button directly below **Cnts**. The entries are alphabetically sorted.

- 3  or  to the required subscriber alias.

- 4 Press the **Menu Select** button directly below **Optn**.

- 5  or  to **Call** and press the **Menu Select** button directly below **Sel**.

- 6  or  to select the call type.

- 7 Hold the radio vertically 1 to 2 inches (2.5 to 5.0 cm) from your mouth.











- 8 Press the **PTT** button to initiate the call. During the call, the display shows the subscriber alias.

- 9 Press and hold the **PTT** button to talk. The LED lights up solid red.
OR
Release the **PTT** button to listen.

- 10 If there is no voice activity for a preprogrammed period of time, the call ends.
OR
The call ends when it reaches the maximum ring time.







Adding a Contact to a Call List

Procedure:

- 1  or  to **Cnts**.
- 2 Press the **Menu Select** button directly below **Cnts**. The entries are alphabetically sorted.
- 3  or  to the entry you want to add to a call list and press the **Menu Select** button directly below **Optn**.
- 4  or  to **Add to CallLst** and press the **Menu Select** button directly below **Sel**.
- 5  or  to the required Call List and press the **Menu Select** button directly below **Add**.
OR
 or  to **Cncl** to return to the main display for Contacts.
- 6 The display shows momentary **Please wait** before showing **<Entry> added to Call List**, confirming the addition of the contact to the list.
- 7 The radio returns to the main display for Contacts.

Removing a Contact from a Call List

Procedure:

- 1  or  to **Cnts**.
- 2 Press the **Menu Select** button directly below **Cnts**. The entries are alphabetically sorted.
- 3  or  to the entry you want to remove from a call list and press the **Menu Select** button directly below **Optn**.
- 4  or  to **Rm frm CallLst** and press the **Menu Select** button directly below **Sel**.
- 5 The display shows **Remove <Entry> frm Call List?**.
- 6 Press the **Menu Select** button directly below **Yes** to remove the entry from the Call List.
OR
Press the **Menu Select** button directly below **No** to return to the main display for Contacts.
- 7 The display shows momentary **Please wait** before showing **<Entry> removed from Call List**, confirming the removal of the contact from the list.
- 8 The radio returns to the main display for Contacts.

■ Scan Lists

Scan lists are created and assigned to individual channels/groups. Your radio scans for voice activity by cycling through the channel/group sequence specified in the scan list for the current channel/group.

Your radio supports different types of Scan Lists:

- Trunking Priority Monitor Scan List
- Conventional Scan List
- Talkgroup Scan List

Please refer to a qualified radio technician for the maximum number of Scan Lists can be programmed in your radio. These lists must be preprogrammed by a qualified radio technician.

📄 Viewing a Scan List

Procedure:

- 1 **◀ or ▶ to ScnL.**

- 2 Press the **Menu Select** button directly below **ScnL**.

- 3 **▲ or ▼** to view the members on the list.

- 4 Press **⏠** to exit the current display and return to the Home screen.

📄 Editing the Scan List

This feature lets you change scan list members and priorities.

Procedure:

Long press the preprogrammed **Scan List Programming** button (side button) and proceed to Step 3.

OR

Move the preprogrammed **Scan List Programming** switch to programming position and proceed to Step 3.

OR

Follow the procedure below.

- 1 **◀ or ▶ to ScnL.**

- 2 Press the **Menu Select** button directly below **ScnL**. The display shows the lists that can be changed.

- 3 **▲ or ▼** to the entry you want to edit.

- 4 Press the **Menu Select** button directly below **Sel** to add and/or change the priority of the currently displayed channel in the scan list.
OR
Press the **Menu Select** button directly below **Del** to delete the currently displayed channel from the scan list.
OR
Press the **Menu Select** button directly below **Rcl** to view the next member of the scan list.

- 5 **▲ or ▼** to select more channels to be added or deleted.
OR

Use the **16-Position Select** knob to select additional channels to be added or deleted.

- 6** Move the **Scan List Programming** switch out of programming position.

OR

Press  to exit scan list programming and return to the Home screen.

See **Viewing and Changing the Priority Status** on page 49 for more information on how to add and/or change the priority of the currently displayed channel in the scan list.

Changing the Scan List Status

Procedure:

- 1** Long press the preprogrammed **Scan List Programming** button (side button).

OR

Move the preprogrammed **Scan List Programming** switch to programming position.



- 2** The display shows the programming mode icon and the first list member.
-

- 3**  or  to the member you want to edit.
-

- 4** Press the **Select** button once to add the currently displayed channel to the scan list.

OR

Press the **Select** button one or more times to change the scan list status icon of the currently displayed channel.

- 5**  or  to select more list members whose scan status you want to change.

OR

Use the **16-Position Select** knob to select another scan list member.

- 6** Move the **Scan List Programming** switch out of programming position.
-

Viewing and Changing the Priority Status

Procedure:

- 1 Below the **Sel**, **Del**, and **Rcl** screen, press the **Menu Select** button directly below **Sel** to view and/or change the priority status of the currently displayed channel.
OR
 Below the **Sel**, **Del**, and **Rcl** screen, press the **Select** button one or more times to view and/or change the scan list status icon of the currently displayed channel.

- 2 A Scan icon indicates that the current channel is in the scan list as a non-priority channel. The LED lights up solid green.
OR
 A Priority-Two Channel Scan icon indicates that the current channel is in the scan list as the Priority-Two channel. The LED blinks green.
OR
 A Priority-One Channel Scan icon indicates that the current channel is in the scan list as the Priority-One channel. The LED rapidly blinks green. You hear all traffic on the Priority-One channel, regardless of traffic on non-priority channels.
OR
 No icon indicates that the current channel is deleted from the scan list.

■ Scan

This feature allows you to monitor traffic on different channels by scanning a preprogrammed list of channels.



Turning Scan On or Off

Procedure:

Press the preprogrammed **Scan** button, or turn the preprogrammed Scan switch to the Scan on or Scan off position, to start or stop scan.

OR

Follow the procedure below.

- 1  or  to **Scan**.

- 2 Press the **Menu Select** button directly below **Scan**.

- 3 The display shows **Scan off** if scan is disabled. Press the **Menu Select** button directly below **Scan** to enable scan.
OR
 The display shows **Scan on** and the scan status icon if scan is enabled. Press the **Menu Select** button directly below **Scan** to disable scan.

- 4 The radio returns to the Home screen.

Making a Dynamic Priority Change (Conventional Scan Only)

While the radio is scanning, the dynamic priority change feature allows you to temporarily change any channel in a scan list (except for the Priority-One channel) to the Priority-Two channel.

This change remains in effect until scan is turned off. Scan then reverts to the preprogrammed (original) setting.

Procedure:

- 1 When the radio locks onto the channel designated as the new Priority-Two channel, press the preprogrammed **Dynamic Priority** button.
- 2 The radio continues scanning the remaining channels in the list.

Deleting a Nuisance Channel

If a channel continually generates unwanted calls or noise (termed a “nuisance” channel), you can temporarily remove the unwanted channel from the scan list.

This capability does not apply to priority channels or the designated transmit channel.

Procedure:

- 1 When the radio is locked onto the channel to be deleted, press the preprogrammed **Nuisance Delete** button.

OR

◀ or ▶ to **Nuis**. Press the **Menu Select** button directly below **Nuis**.

- 2 The radio continues scanning the remaining channels in the list.

Restoring a Nuisance Channel

Procedure:

To restore the deleted nuisance channel, do **one** of the following:

- Turn the radio off and then turning it on again.

OR

- Stop and restart a scan via the preprogrammed **Scan** button or menu.

OR

- Change the channel via the **16-Position Select** knob.

■ Call Alert Paging

This feature allows your radio to work like a pager.

Even if other users are away from their radios, or if they are unable to hear their radios, you can send them an individual Call Alert page. You can also verify if a radio is active on the system.

Depending on how your radio is programmed, when you make an Enhanced Private Call, the radio either automatically sends a call alert page if there is no answer after the maximum ring time, **OR** when you press the **PTT** button.

Note: This feature must be preprogrammed by a qualified radio technician.

📄 Receiving a Call Alert Page

Procedure:

- 1 When you receive a Call Alert page, you hear four repeating alert tones and the LED blinks green.
 - 2 The call received icon blinks and the display shows **Page received**.
-

Press any button to clear the Call Alert page. See **Making a Talkgroup Call** on page 34 or **Making a Private Call (Trunking Only)** on page 34 for more information on returning the call.

📄 Sending a Call Alert Page

Note: The radio automatically exits the feature, if the feature inactivity timer is enabled, when the radio is left idle and the timer expires. You will hear the Menu Inactive Exit Tone upon feature exit.

Procedure:

Press the preprogrammed **Quick Access (One-Touch) Call Alert Paging** button to send a page to the preprogrammed ID and proceed to Step 5.

OR

Follow the procedure below.

- 1 ◀ or ▶ to **Page**.
 - 2 Press the **Menu Select** button directly below **Page**.
 - 3 Press **Cnts** to scroll through and select the required ID.
OR
▲ or ▼ to the required ID.
 - 4 Press the **PTT** button to send the page.
 - 5 The display shows **Paging... <Number>**.
 - 6 If the call alert page is sent successfully, you hear a tone and the display shows **Ack received**.
OR
If the call alert page is not acknowledged, you hear a low tone and the display shows **No acknowledge**.
-

- 7 The radio returns to the Home screen.

OR

Press the **Menu Select** button directly below **Ok** to return to the Contacts screen.

OR

Follow the procedure below.

- 1 ◀ or ▶ to **Call**.
-

- 2 Press the **Menu Select** button directly below **Call**.
-

- 3 ▲ or ▼ to select the alias or ID, and press the **PTT** button to initiate the call.
-

- 4 If the target radio does not respond after a preprogrammed period of time, the display shows **Send page?**.
-

- 5 Press the **Menu Select** button directly below **Yes** to send the call alert page.

OR

Press the **Menu Select** button directly below **No** to exit the screen without sending the call alert page.

- 6 The display shows **Paging... <Alias>**.
-

- 7 If the call alert page is sent successfully, you hear a tone and the display shows **Ack received**.

OR

If the call alert page is not acknowledged, you hear a low tone and the display shows **No acknowledge**.

- 8 The radio returns to the Home screen.

OR

Press the **Menu Select** button directly below **Ok** to return to the Contacts screen.

■ Emergency Operation

The Emergency feature is used to indicate a critical situation.

If the **Top (Orange)** button is preprogrammed to send an emergency signal, this signal overrides any other communication over the selected channel.

Your radio supports the following Emergency modes:

- Emergency Alarm
- Emergency Call (Trunking Only)
- Emergency Alarm with Emergency Call
- Silent Emergency Alarm

Check with your dealer or system administrator for more information on the programming of this feature.

Only **one** of the Emergency modes above can be assigned to the preprogrammed **Emergency** button.

Note: To exit emergency at any time, press and hold the preprogrammed **Emergency** button for about a second.

Man Down is an alternate way to activate the Emergency feature on the condition the Emergency must be set up for this feature to operate.

See **Man Down** on **page 59** for details.

📄 Sending an Emergency Alarm

This feature allows you to send a data transmission, which identifies the radio sending the emergency, to the dispatcher.

Note: Emergency button press timer by default is set to 1 second. This timer is programmable from 0 – 6 seconds by a qualified technician.

Procedure:

- 1 Press the preprogrammed **Emergency** button.
- 2 The display shows **Emergency** and the current zone or channel. You hear a short, medium-pitched tone and the LED blinks red momentarily.
OR
You hear the radio sounds a short low-pitched tone to indicate the selected channel does not support emergency and rejects to launch emergency mode. The display shows **No emergency**, if the selected channel does not support emergency.
- 3 When you receive the dispatcher's acknowledgment, the display shows **Ack received**. You hear four tones, the alarm ends, and the radio exits the Emergency Alarm mode.
OR
If no acknowledgement is received, the display shows **No acknowledge**. The alarm ends and the radio exits the Emergency Alarm mode.

Sending an Emergency Call (Trunking Only)

This feature gives your radio priority access on a channel.

Note: The radio operates in the normal dispatch manner while in Emergency Call, except, if enabled, it returns to one of the following:

- **Tactical/Non-Revert** – You talk on the channel you selected before you entered the emergency state.
- **Non-Tactical/Revert** – You talk on a preprogrammed emergency channel. The emergency alarm is sent on this same channel.

Procedure:

- 1 Press the preprogrammed **Emergency** button.
- 2 The display shows **Emergency** and the current zone or channel. You hear short, medium-pitched tone and the LED blinks red momentarily.
OR
You hear the radio sounds a short low-pitched tone to indicate the selected channel does not support emergency and rejects to launch emergency mode.
- 3 Hold the radio vertically 1 to 2 inches (2.5 to 5.0 cm) from your mouth.
- 4 Press and hold the **PTT** button. Speak clearly into the microphone.

- 5 Release the **PTT** button to end the transmission and wait for a response from the dispatcher.
- 6 Press and hold the preprogrammed **Emergency** button for about a second to exit the Emergency Call mode.

Sending an Emergency Alarm with Emergency Call

Procedure:

- 1 Press the preprogrammed **Emergency** button.
- 2 The display shows **Emergency** and the current zone or channel. You hear a short, medium-pitched tone and the LED blinks red momentarily.
OR
You hear the radio sounds a short low-pitched tone to indicate the selected channel does not support emergency and rejects to launch emergency mode.
- 3 The radio enters the Emergency Call state when:
You receive the dispatcher's acknowledgment. The display shows **Ack received**.
OR
You receive no acknowledgement. The display shows **No acknowledge**.
OR
You press the **PTT** button while in the Emergency Alarm mode.

- 4 Hold the radio vertically 1 to 2 inches (2.5 to 5.0 cm) from your mouth.
- 5 Press and hold the **PTT** button. Speak clearly into the microphone.
- 6 Release the **PTT** button to end the transmission and wait for a response from the dispatcher.
- 7 Press and hold the preprogrammed **Emergency** button for about a second to exit the Emergency Call mode.

Sending a Silent Emergency Alarm

This feature allows you to send an Emergency Alarm to another radio without any audio or visual indicators.

Procedure:

- 1 Press the preprogrammed **Emergency** button.
- 2 The display shows no changes, the LED does not light up, and you hear no tones.
- 3 The silent emergency state continues until you:
Press and hold the preprogrammed **Emergency** button for about a second to exit the Silent Emergency Alarm mode.
OR
Press and release the **PTT** button to exit the Silent Emergency Alarm mode and enter regular dispatch or Emergency Call mode.

Note: For **ALL** Emergency signals, when changing channels:

- If the new channel is also preprogrammed for Emergency, you can change channels while in Emergency operation. The emergency alarm or call continues on the new channel.
- If the new channel is **NOT** preprogrammed for Emergency, the display shows **No emergency**, and you hear an invalid tone until you exit the Emergency state or change to a channel preprogrammed for Emergency.

Using the Emergency Keep-Alive Feature

This feature, when enabled, prevents the radio from being turned off via the **On/Off Control Knob** when the radio is in the Emergency state.

Note: The radio only exits the Emergency state using one of the ways mentioned in the previous sections.

See ***Sending an Emergency Alarm*** on page 53, ***Sending an Emergency Call (Trunking Only)*** on page 54, ***Sending an Emergency Alarm with Emergency Call*** on page 54, or ***Sending a Silent Emergency Alarm*** on page 55.

■ Fireground (Conventional Only)

The portable Fireground Communications System is designed for deployment at an incident scene. It consists of five central components:

- Your APX portable radios
- Incident Management Software
- Command Terminal
- Radio Frequency (RF) Modem
- Portable Repeater (Optional)

These components provide on-scene and inbuilding radio coverage, and enhanced personnel accountability and monitoring.

The radio helps to indicate your presence on the scene if it is in the range of the Incident Commander's command terminal.

Each Fireground Communication System radio automatically reports your radio's ID on the commander's mobile command terminal. Your name, riding position and sector are all can be configured to be seen at the Commander's command terminal.

If you have a critical situation, you can press the Emergency button which activates an alarm on the Incident Management Software at the command terminal.

The Fireground signals transmission is always exchanging data between your radio and the RF Modem and command terminal. The status of your radio includes

- Powering up or down the radio
- Automatic response to Polling
- Response to Evacuation commands
- Pressing the PTT button to make voice transmission
- Sending an Emergency Alarm and Call

Entering Fireground Zone Channel

Procedure:

1 Upon Powering Up

If the Fireground Zone Channel is set as default, you hear gurgle tone and the home screen. You are in Fireground zone channel.

OR

If the Fireground Zone Channel is set as default, but you hear a short, low-pitched tone, the display shows **Reg failed** to indicate that the command terminal does not respond to Fireground Zone Channel. Get qualified technician for assistance.

OR

Your home channel is not Fireground Zone Channel, toggle or change the radio zone channel to Fireground Zone Channel.

2 Listen for a transmission. Adjust the Volume Control Knob if necessary.

3 Press and hold the preprogrammed **Volume Set** button to hear the volume set tone. Adjust the Volume Control knob if necessary. Release the Volume Set button.

OR

At the desired Fireground zone and channel, press the preprogrammed **Monitor** button and listen for activity. Adjust the Volume Control knob if necessary.

OR

If your radio is working in Fireground Zone Channel, proceed to next step.

4 Press and hold the **PTT** button to transmit. The LED lights up solid RED while transmitting. Talk into the microphone clearly if needed.

5 Release the **PTT** button to receive. You hear a Transmit End Tone.

Responding to Evacuation Indicator

When Incident Commander triggers Evacuation signal from his command terminal, the RF Modem updates everyone in the Fireground Communication System with the order to evacuate the incident site.

Procedure:

1 Your radio sounds the Evacuation Tone at the profile's maximum alert tone volume level. The display shows **EVACUATE**.

2 Moving the volume knob to adjust the volume of the Evacuation Tone from full volume.

OR

Perform any action on the radio other than volume adjustments to cancel the evacuation indications and update the command terminal.

OR

If preprogrammed with Manual Acknowledgement of Evacuation Command, press the **PTT** button shall cancel the indications and acknowledge the command terminal.

■ Tactical Public Safety(TPS) (Conventional Only)

Using TPS Normal Transmission

TPS enabled the users of a group to identify a transmission starts and ends clearly by displaying the caller's name or ID on the radio display.

Procedure:

- 1 At TPS Zone Channel
Press **PTT** button to transmit. Talk clearly into the microphone. Release **PTT** button to listen.
OR
Receive and listen to call, the radio displays the caller's name or ID.
-

Using TPS Emergency Transmission

Emergency Beacon – During Emergency if the TPS radio user pushes the Emergency button, the radio sounds a Beacon at the maximum volume of the radio at radio's internal speaker and it is not adjustable. This beacon goes to silent when user presses the PTT button for voice transmission.

Emergency Call De-Key Sidetone – The radio sounds an alert tone to remind radio user that the Emergency Mode is still active after user releases the PTT button for an Emergency call transmission. The volume of loudness depends on the maximum tone at your radio profile.

Procedure:

- 1 Press the **Emergency** button to enter Emergency Mode. You hear Emergency Beacon.
 - 2 Press **PTT** button to make Emergency Call.
 - 3 Release to listen. You hear Emergency Call De-Key Sidetone. After a short pause, you hear Emergency Beacon.
 - 4 Long press Emergency button to exit Emergency mode and cancel Emergency Beacon.
-

■ Man Down

Man Down condition is determined based upon the radio tilt angle or a combination of radio tilt angle and the lack of radio motion.

Man Down feature is an alternate way to activate the Emergency feature if Emergency has been programmed in your radio.

Your radio automatically activates Emergency Alarm or Call when the radio achieves or passes a tilt angle threshold or a combination of the angle threshold and radio motion below the motion sensitivity level, depending upon how the radio is programmed. The radio must stay in this condition for a preprogrammed amount of time before the Emergency Alarm or Call is activated.

Note: It is recommended that an Emergency button is preprogrammed in order to allow the user to exit the emergency condition.

The Man Down feature provides a **Clear** function to the user. After a Man Down condition has been detected, the user can press a preprogrammed **Clear** button or preprogrammed Menu Select button to cancel the Man Down condition. The radio remains in the Man Down state without triggering an emergency condition until the radio is moved out of the Man Down state, at which point Man Down functionality resumes.

The Man Down feature has three phases:

- i The radio senses the Man Down condition and **Pre-Alert Timer** is initiated.
- ii Man Down condition continues for the time duration defined in the **Pre-Alert Timer** field. At the end of this time, the radio alerts the user on the Man Down status with an audible alert tone and **Man Down** text on the screen. The Post-Alert Timer also initiates at this point.
- iii Man Down condition continues for the time duration defined in the **Post-Alert Timer** field. Once the timer expires, the Emergency alarm is transmitted. The Man Down Clear function is used in this phase to cancel the Man Down condition.

The following scenarios affect the timers:

- Pressing the PTT button suspends the Man Down timers; releasing the PTT button reinitiates the Pre-Alert Timer.
- Pressing other buttons on the radio does not impact these timers.
- Repositioning the radio exits the Man Down feature, which stops and resets the timers.
- Pressing a preprogrammed **Clear** button or pressing a Menu Select button preprogrammed for **Clear** stops and resets the timers. The timers do not restart until the radio is repositioned.

Note: Emergency must be set up for this feature to operate. For details on operating the Emergency alerts, please see **Emergency Operation** on page 53.

If the radio is preprogrammed to **horizontal** only, it must be worn in a **vertical** position otherwise the Man Down alert may be inadvertently triggered.

When the radio is programmed with Man Down feature, special care is required when charging the radio with a **wall mounted charger**. See **Handling Your Radio** on page 113 for details.

Pre-Alert Timer

This timer sets the amount of time that a Man Down condition must be present before the radio-user is warned of the Man Down condition.

When the radio detects that it has returned to the vertical position or when the radio detects motion, the Pre-Alert timer stops and is reset.

The Pre-Alert timer reinitiates when the radio detects it is in the horizontal position or motionless again.

Post-Alert Timer

This timer sets the amount of time the radio needs to remain in the Man Down condition before the Emergency alarm is transmitted. When the Post-Alert Timer is initiated, the radio alerts the user with an audible tone and displays the **“Man-Down”** text.

See **Exiting Man Down Feature** on page 61 to exit Man Down feature.

Alerting User When Man Down Feature is Triggered

The Man Down alert tone volume is directly related to the radio's volume. Ensure that the radio's volume is loud enough so that the user does not miss the Post-Alert tone.

Note: If the radio is programmed with Silent Emergency, the radio inhibits the alert tone and visual alert associated with the emergency feature.

Note: If the radio is programmed in Surveillance Mode, the radio inhibits all tones and lights on the radio including the Man Down tones.

Triggering Emergency

When the user does not clear the Man Down condition and the Post-Alert Timer comes to an end, Emergency Alarm or call is triggered. The radio sends emergency message to units within the same Talkgroup. The radio also sends ID number and GPS coordinates to dispatcher if these features are enabled. User can exit Emergency following the Emergency procedure. See **Emergency Operation** on page 53 for details.

Note: At this point the Man Down features is complete. Use normal Emergency procedures to cancel Emergency transmissions.

Exiting Man Down Feature

If you are not in a real Man Down situation, you should exit the Man Down feature and prevent emergency from going off with the following operation.

Procedure:

Repositioning the radio or shaking the radio (when motion sensitivity is enabled).

OR

Press the preprogrammed **Man Down Clear** button to exit.

OR

Press the **Menu Select Button** below **Clr** to exit.

Re-Initiating Man Down

After exiting the Emergency Operation when the radio is still in Man Down condition (tilted achieving threshold angle or motionless), user must first exit Man Down condition to then re-initiate the Man Down feature.

Procedure:

Return the radio to the vertical position

OR

Shake the radio (when motion sensitivity is enabled).

Testing the Man Down Feature

Note: Enable the Emergency feature with Silent Alarm disabled, but not in Surveillance Mode before running this test on the radio.

Procedure:

When Man Down is enabled on the radio:

- 1 Turn the radio on and place in the vertical position, for at least 5 seconds.

- 2 Lay the radio down in the horizontal position.

- 3 Wait for alert tone.

- 4 The radio alerts with audible tone and displays **Man-Down**.
OR
If no tone is heard, make sure that the Man Down feature is enabled on your radio. If Man Down feature was not enabled, please enable it and go through steps 1,2 and 3 again.
OR
If the Man Down feature is enabled and no tone is heard, send the radio to a qualified technician.

Handling Man Down Functional Error Messages

Procedure:

- 1 If your radio display shows one of the following error messages: **Hardware board absent**, **Man-Down Hw error** or **Hw Board Mismatch**. Send the radio to the qualified technician to fix this error.

■ Automatic Registration Service (ARS)

This feature provides an automated data application registration for the radio. When you turn on the radio, the device automatically registers with the server.

Data applications within the fixed network can determine the presence of a device on the system and send data to the device. For example: Text Messaging Service (TMS).

The Automatic Registration Service for the radio consists of two (2) modes:

- ARS Server Mode (default mode)
- ARS Non-Server Mode

Note: The default ARS mode can be changed by a qualified radio technician using the radio's programming software.

📄 Selecting or Changing the ARS Mode

Procedure:

Turn the preprogrammed **16-Position Select** knob, once the zone you want is displayed, to the desired mode.

OR

Follow the procedure below.

- 1 ◀ or ▶ to **Chan**.
- 2 Press the **Menu Select** button directly below **Chan**. The display shows the current channel name.
- 3 ▲ or ▼ to the required channel or mode.
- 4 In ARS Server Mode, the display shows the User Login Indicator icon, the zone, and ARS server channel.
OR
In ARS Non-Server Mode, the display shows the User Login Indicator icon, the zone, and ARS non-server channel.
OR
If the channel or mode selected is unprogrammed, the display shows **Unprogrammed**. Repeat Step 3.
- 5 Press **Sel** to confirm the displayed channel.

Accessing the User Login Feature

This feature allows you as the user to be associated with the radio. With this association, every data application (Example: Text Messaging Service) takes on a friendly username.

You can still send text messages without logging in as a user. The user login feature only enables the recipient of your message to identify you as the sender by assigning a username to your message.

Note: A predefined username that's set more than the maximum allowed characters is an invalid name.





Logging In as a User



Procedure:

Press the preprogrammed **User Login** button and proceed to Step 3.

OR

Follow the procedure below.

- 1  or  to **User**.
 - 2 Press the **Menu Select** button directly below **User**.
 - 3 The display shows the User Login screen.
 - 4  or  to scroll through the list of predefined usernames. Press the **Menu Select** button directly below **Login** to select the predefined username.
- OR**

Press and hold  or  to scroll through the list of predefined usernames at a fast scroll rate.

Press the **Menu Select** button directly below **Login** to select the predefined username.

- 5 If the selected predefined username is invalid, the display shows momentary **Invalid ID**. Repeat Step 4.
- 6 In ARS Server Mode, the display shows the User Login Indicator icon, the ID, and **In progress**, with **Cncl**.
OR
In ARS Non-Server Mode, the display shows the User Login Indicator icon, the ID, and **Logged in**, with **Logt** and **Exit**.
OR
In non-ARS enabled mode, the display shows **Offline**, with **Logt** and **Exit**.
- 7 If the username is invalid, login fails and the user login failure indicator (IP indicator) icon blinks. The display also shows momentary **Login failed**. Repeat Step 4.
OR
Press the **Menu Select** button directly below **Cncl** to cancel the login in progress screen and return to the initial user login screen.
OR
Wait for the logged in confirmation screen. If the login process is successful, the display shows the successful user login indicator (IP indicator) icon and **Logged in**, with **Logt** and **Exit**.

Logging Out

When you have logged in or you are using Offline mode, you can log out.

Procedure:

- 1 Press the **Menu Select** button directly below **Logt**.
- 2 The display shows **Clear private data?**.
OR
If the Delete Messages On Session End feature is enabled, the radio clears the private data and returns to User Login screen.
- 3 Select **Yes** to clear all your private data. The display shows momentary **Private data cleared**.
OR
Select **No** to keep your private data.

Note: Private data refers to all messages in the text messaging inbox, Draft, and Sent folder. The next user is able to access the Inbox, Draft and Sent messages if private data is not deleted.

■ Text Messaging Service (TMS)

This features allows you to quickly send and receive messages and run database queries directly from your radios.

The types of text messages available:

- A new text message (free form message).
- A predefined message (quick text message).
- An edited quick text message.

The main menu consists of the following options:

- Inbox
- Compose
- Drafts
- Sent

Note: See **Status Icons** on page 15 for more information on the TMS icons and **TMS Menu Options** on page 20 for more information on each menu option.

Accessing the TMS Features

Note: The radio automatically exits the feature, if the feature inactivity timer is enabled, when the radio is left idle and the timer expires. You will hear the Menu Inactive Exit Tone upon feature exit.

Press the **Menu Select** button directly below **Back** at any time to return to the previous screen.

Procedure:





Press the preprogrammed **Data Feature** button or the **TMS Feature** button to access the TMS feature screen.

OR

Press and hold the preprogrammed **Data Feature** button or the **TMS Feature** button to access the Inbox.

OR

Follow the procedure below.

- 1  or  to **TMS**.
- 2 Press the **Menu Select** button directly below **TMS** to access the TMS feature screen.
- 3  or  to scroll through the main menu options.

Sending a Quick Text Message

Quick Text messages are messages that are predefined and usually consist of messages that are used most frequently.









Each Quick Text message has a **maximum** length of 50 characters. You can select the required text from the Quick Text.

Procedure:

Press the preprogrammed **Quick Text** button and proceed to Step 4.

OR

Follow the procedure below.

- 1  or  to **TMS**.
- 2 Press the **Menu Select** button directly below **TMS** to access the TMS feature screen.
- 3  or  to **Compose** and press the **Menu Select** button directly below **Sel**.
- OR**
Press the **Menu Select** button directly below **Exit** to return to the Home screen.
- 4  or  to **Quick Text** and press the **Menu Select** button directly below **Sel** for a predefined message.
- 5  or  to scroll through the list of messages and press the **Menu Select** button directly below **Sel** to select the required message.

- 6 Press the **Menu Select** button directly below **Optn**.

 - 7 ▲ or ▼ to **Send Message** and press the **Menu Select** button directly below **Sel**.

 - 8 ▲ or ▼ to scroll through the address list and highlight the required address.

 - 9 Press the **Menu Select** button below **Sel** or the **PTT** button to send the message.

 - 10 The display shows the **Send Message** screen and **Sending msg**.

 - 11 If the message is sent, you hear a tone and the display shows **Msg sent**.
OR
If the message is not sent, you hear a low tone and the display shows **Send failed**.

 - 12 The radio returns to main TMS screen.

- Note:** You can append a priority status and/or a request reply to your message. See *Using the Priority Status and Request Reply Features* on page 67 for more information.

Using the Priority Status and Request Reply Features

Before sending your message, you can append a priority status and/or a request reply to your message.

Appending a Priority Status to a Text Message

Note: The Priority Status icon on a message does not imply that the message gets higher priority over the other messages when it is being transmitted. It is just an indication that can be embedded into a message to let the receiver know that the message is important.

Procedure:

- 1 Press the **Menu Select** button directly below **Optn**.

- 2 ▲ or ▼ to **Mark Important** and press the **Menu Select** button directly below **Sel** to indicate the message as important.

- 3 The priority status icon appears beside the normal message icon on the label bar.

Removing a Priority Status from a Text Message

Procedure:

- 1 Press the **Menu Select** button directly below **Optn.**
- 2 ▲ or ▼ to **Mark as Normal** and press the **Menu Select** button directly below **Sel** to remove the priority status from the message.
- 3 The display shows the normal message icon on the label bar.

Appending a Request Reply to a Text Message

Procedure:

- 1 Press the **Menu Select** button directly below **Optn.**
- 2 ▲ or ▼ to **Req Reply** and press the **Menu Select** button directly below **Sel** to request for a reply.
- 3 The request reply icon appears beside the normal message icon on the label bar.

Removing a Request Reply from a Text Message

Procedure:

- 1 Press the **Menu Select** button directly below **Optn.**
- 2 ▲ or ▼ to **No Req Reply** and press the **Menu Select** button directly below **Sel** to remove the request reply icon from the message.
- 3 The display shows the normal message icon on the label bar.

Appending a Priority Status and a Reply Request to a Text Message

Procedure:

- 1 Press the **Menu Select** button directly below **Optn.**
- 2 ▲ or ▼ to **Mark Important** and press the **Menu Select** button directly below **Sel** to indicate the message as important.
AND
▲ or ▼ to **Req Reply** and press the **Menu Select** button directly below **Sel** to request for a reply.
- 3 The priority status and request reply icons appear beside the normal message icon on the label bar.

Removing a Priority Status and a Reply Request from a Text Message

Procedure:

- 1 Press the **Menu Select** button directly below **Optn**.
- 2 **▲** or **▼** to **Mark as Normal** and press the **Menu Select** button directly below **Sel** to indicate the message as normal and no request reply.
AND
▲ or **▼** to **No Req Reply** and press the **Menu Select** button directly below **Sel** to request for a reply.
- 3 The display shows the normal message icon on the label bar.

Managing Text Messages

Receiving a Text Message

Note: When you receive a message that is flagged with the “Request Reply” icon, you must manually respond to the sender that you have received the message. The system will not automatically send back a notification that the radio has received such message.

Procedure:

When you receive a message, press and hold the preprogrammed **Data Feature** button or the **TMS Feature** button to access the Inbox and go to Step 3.

OR

Follow the procedure below.

- 1 The new message icon appears and the display shows momentary **New msg**.
- 2 Press the **Menu Select** button directly below **TMS**.
- 3 **▲** or **▼** to **Inbox** and press the **Menu Select** button below **Sel**.
- 4 The display shows a list of aliases or IDs, with the sender of the latest received message on top.

Viewing a Text Message from the Inbox

The Inbox can hold up to thirty (30) messages.

Note: ▲ or ▼ to read the message if fills more than one screen.

Procedure:

Press the preprogrammed **Data Feature** button or the **TMS Feature** button to access the TMS feature screen, and proceed to Step 3.

OR

Press and hold the preprogrammed **Data Feature** button or the **TMS Feature** button to access the Inbox and proceed to Step 4.

OR

Follow the procedure below.

- 1 ▲ or ▼ to **TMS**.
- 2 Press the **Menu Select** button directly below **TMS** to access the TMS feature screen.
- 3 ▲ or ▼ to **Inbox** and press the **Menu Select** button below **Sel**.
- 4 The display shows a list of aliases or IDs, with the sender of the latest received message on top.
- 5 ▲ or ▼ to the required aliases or ID and press the **Menu Select** button below **Sel** to view the message.

While on the view message screen, press the **Menu Select** button directly below **Rply**, **Del**, or **Back** to access the option.

- Select **Rply** to reply the message.
- Select **Del** to delete the message.
- Select **Back** to return to the previous screen.

Note: The icon at the top right corner of the screen indicates the status of the message. See **Text Messaging Service (TMS) Icons** on page 19 for more information.

Replying to a Received Text Message

Note: The original date and time stamp, address and message content is automatically appended to the reply message.

Procedure:

- 1 ▲ or ▼ to the required aliases or ID and press the **Menu Select** button below **Sel** to view the message.
- 2 Press the **Menu Select** button directly below **Rply** to reply to a message.
- 3 The display shows a list of **Quick Text**. Press the **Menu Select** button directly below **Optn** once you have selected the message.
- 4 ▲ or ▼ to **Send Message** and press the **Menu Select** button directly below **Sel** to send the message.

- 5 The display shows the **Send Message** screen and **Sending msg.**

Press the **Menu Select** button directly below **Back** at any time to return to the previous screen.

Note: You can append a priority status and/or a request reply to your message. See **Using the Priority Status and Request Reply Features** on page 67 for more information.

Managing Sent Text Messages

Once a message is sent to another radio, it is saved in the Sent folder. The most recent sent text message is always added to the top of the Sent list.

The Sent folder is capable of storing a maximum of ten (10) last sent messages. When the folder is full, the oldest message in the folder is deleted when the 11th message comes in.







Viewing a Sent Text Message

Procedure:

Press the preprogrammed **Data Feature** button or the **TMS Feature** button to access the TMS feature screen, and proceed to Step 3.

OR

Follow the procedure below.

- 1  or  to **TMS**.
- 2 Press the **Menu Select** button directly below **TMS** to access the TMS feature screen.
- 3  or  to **Sent** and press the **Menu Select** button below **Sel**.
- 4 The display shows a list of aliases or IDs, with the recipient of latest sent message on top.
- 5  or  to the required aliases or ID and press the **Menu Select** button below **Sel** to view the message.

While on the view message screen, press the **Menu Select** button directly below **Optn**, **Del**, or **Back** to access the option.

- Select **Optn** to configure the message settings.
- Select **Del** to delete the message.
- Select **Back** to return to the previous screen.

Note: The icon at the top right corner of the screen indicates the status of the message. See **Text Messaging Service (TMS) Icons** on page 19 for more information.

Sending a Sent Text Message

Procedure:

- 1** Press the **Menu Select** button directly below **Optn** while viewing the message.

- 2** **▲** or **▼** to **Send Message** and press the **Menu Select** button directly below **Sel**.

- 3** **▲** or **▼** to scroll through the address list and highlight the required address.

- 4** Press the **Menu Select** button below **Sel** or the **PTT** button to send the message.

- 5** The display shows the **Send Message** screen and **Sending msg**.

Press the **Menu Select** button directly below **Back** at any time to return to the previous screen.

Note: You can append a priority status and/or a request reply to your message. See **Using the Priority Status and Request Reply Features** on **page 67** for more information.

Deleting a Text Message

Procedure:

From the Inbox or Sent screen:

- 1** **▲** or **▼** to scroll through the messages.

- 2** Press the **Menu Select** button directly below **Del** to delete the current message.



Deleting All Text Messages

Procedure:



Press the preprogrammed **Data Feature** button or the **TMS Feature** button to access the TMS feature screen, and proceed to Step 3.

OR

Follow the procedure below.

- 1  or  to **TMS**.

 - 2 Press the **Menu Select** button directly below **TMS** to access the TMS feature screen.

 - 3  or  to **Inbox** or **Sent** then press the **Menu Select** button below **Clr** to select all messages in the selected folder.

 - 4 The display shows **Del All?**.

 - 5 Press the **Menu Select** button directly below **Yes** to delete all the messages in the selected folder.
- OR**
Press the **Menu Select** button directly below **No** to return to the main TMS screen.
-

Secure Operations

Secure radio operation provides the highest commercially available level of voice security on both trunked and conventional channels.

Unlike other forms of security, Motorola digital encryption provides signaling that makes it virtually impossible for others to decode any part of an encrypted message.

Selecting Secure Transmissions

Procedure:

Turn the preprogrammed **Secure/Clear** switch to the secure position.

Note: If the selected channel is preprogrammed for clear-only operation – when you press the **PTT** button, you hear an invalid mode tone and the display shows **Clear TX only**.

The radio will not transmit until you set the **Secure/Clear** switch to the clear position.

Selecting Clear Transmissions

Procedure:

Turn the preprogrammed **Secure/Clear** switch to the clear position.

Note: If the selected channel is preprogrammed for secure-only operation – when you press the **PTT** button, you hear an invalid mode tone and the display shows **Secure TX only**.

The radio will not transmit until you set the **Secure/Clear** switch to the secure position.

The radio can be configured to ignore the clear voice or insecured transmission when the radio is in secured transmission. Check with your agent for details.

Managing Encryption

Loading an Encryption Key

Note: Refer to the key-variable loader (KVL) manual for equipment connections and setup.

Procedure:

- 1 Attach the KVL to your radio.

- 2 The display shows **Keyloading**, and all other radio functions, except for power down, backlight, and volume, are locked out.

- 3 Select the required keys and press the **Menu Select** button directly below **LOAD** on the KVL. This loads the encryption keys into your radio.

- 4 When the key has been loaded successfully, you hear a short tone for single-key radios.
OR
When the key has been loaded successfully, you hear an alternating tone for multikey radios.

Using the Multikey Feature





This feature allows the radio to be equipped with different encryption keys and supports the DES-OFB algorithm.

There are two types:

- **Conventional Multikey** – The encryption keys can be tied (strapped), on a one-per-channel basis, through Customer Programming Software. In addition, you can have operator-selectable keys, operator-selectable keysets, and operator-selectable key erasure. If talkgroups are enabled in conventional, then the encryption keys are strapped to the talkgroups.
- **Trunked Multikey** – If you use your radio for both conventional and trunked applications, you have to strap your encryption keys for trunking on a per-talkgroup or announcement-group basis. In addition, you may strap a different key to other features, such as dynamic regrouping, failsoft, or emergency talkgroup. You can have operator-selectable key erasure.

Selecting an Encryption Key

Procedure:

- 1  or  to **Key**.
- 2 Press the **Menu Select** button directly below **Key**. The display shows the last user-selected and stored encryption key, and the available menu selections.
- 3  or  to scroll through the encryption keys.
- 4 Press the **Menu Select** button directly below **Sel** to save the newly selected key and return to the Home screen.

OR

Press , the **PTT** button, or the **Menu Select** button directly below **Exit** to exit.

OR

Turn the **16-Position Select** knob to exit.

Note: If the selected key is erased, you hear a momentary keyfail tone and the display shows **Key fail**.

OR

If the selected key is not allowed, you hear a momentary illegal key tone and the display shows **Illegal key**.

Selecting a Keypad



This feature allows you to select one or more groups of several encryption keys from among the available keys stored in the radio.

For example, you could have a group of three keys structured to one keypad, and another group of three different keys structured to another keypad; by changing keypads, you would automatically switch from one set of keys to the other.



Every channel to which one of the original keys was tied now has the equivalent new key instead.

Note: Press , the **PTT** button, or the **Exit** menu selection, or turn the **16-Position Select** knob to exit this menu at any time without changing the keypad selection.

Procedure:

- 1  or  to **KSet**.

- 2 Press the **Menu Select** button directly below **KSet**. The display shows the last user-selected and stored keypad, and the available keypad menu selections.

- 3  or  to scroll through the keypads.



- 4 Press the **Menu Select** button directly below **Sel** to save the newly selected keypad.

- 5 The radio exits keypad selection and returns to the Home screen.



Erasing the Selected Encryption Keys

This feature allows you to erase all or selected encryption keys.



Procedure:

- 1  or  to **Eras**.

- 2 Press the **Menu Select** button directly below **Eras**. The display shows the last user-selected and stored encryption key, and the available menu selections.

- 3  or  to the desired encryption key.

- 4 Press the **Menu Select** button directly below **Optn**. The display shows the available key erase options.

- 5  or  to the required option and press the **Menu Select** button directly below **Sel**.

- 6 At **Erase all keys?**, press the **Menu Select** button directly below **Yes** to erase all the encryption keys in the radio **OR No** to return to the previous screen.
OR
At **Erase single key?**, press the **Menu Select** button directly below **Yes** to erase the displayed encryption key **OR No** to return to the previous screen.

- 7 Press , the **PTT** button, or the **Menu Select** button directly below **Exit** to exit.
OR
Turn the **16-Position Select** knob to exit.

OR

Use the preprogrammed **Top Side (Select)** button and **Top (Orange)** button to erase the single key in radios with the single-key option, and to erase all keys in radios with the multikey option.

- 1 Press and hold the **Top Side (Select)** button.
- 2 While holding **Top Side (Select)** button down, press the **Top (Orange)** button.
- 3 The display shows **Please wait**.
- 4 When all the encryption keys have been erased, the display shows **All keys erased**.

Note: **DO NOT** press the **Top (Orange)** button before pressing the **Top Side (Select)** button, unless you are in an emergency situation as this sends an emergency alarm.

Requesting an Over-the-Air Rekey (ASTRO Only)

This feature, also known as **OTAR**, allows the dispatcher to reprogram the encryption keys in the radio remotely. The dispatcher performs the rekey operation upon receiving a rekey request from the user.

Procedure:

- 1 **◀** or **▶** to **Reky**.
- 2 Press the **Menu Select** button directly below **Reky**.
- 3 Press the **PTT** button to send the rekey request.
OR
Press the **PTT** button again, or the **Home** or **Emergency** button, to exit the feature and transmit in normal mode.
- 4 If the rekey operation fails, you hear a bad-key tone and the display shows **Rekey fail**.

Note: The rekey operation failure indicates that your radio does not contain the Unique Shadow Key (USK). This key must be loaded into the radio with the key-variable loader (KVL) before the rekey request can be sent.

Refer to your local key management supervisor for more information.

MDC Over-the-Air Rekeying (OTAR) Page

This feature allows to view or define MDC Over-the-Air Rekeying (OTAR) features. It is applied only when operating in secure encrypted mode and only for conventional communications. In addition to Rekey Requests, OTAR transmissions include Delayed Acknowledgements, and Power-up Acknowledgements.

Some of the options selected may also need to be set up at the Key Management Controller (KMC) site to work properly.

Note: This feature must be preprogrammed by a qualified radio technician. Check with your dealer or system administrator for more information.

Infinite UKEK Retention

This feature enables Unique Key Encryption Key (UKEK) to be permanently stored in the radio even when all of the encryption keys is erased. Without this UKEK key, the radio could not be over the air rekeyed.

Note: This feature must be preprogrammed by a qualified radio technician. Check with your dealer or system administrator for more information.

Hear Clear

There are two components of Hear Clear.

1 Companding:

Reduces the channel noise, e.g. OTA transmission, that is predominantly present in UHF2 and 900 MHz channel with the following features.

- **Compressor** – reduces the background noise flow and the speech signal at transmitting radio.
- **Expander** – expands the speech while the noise flow remains the same at receiving radio.

2 Random FM Noise Canceller (Flutter Fighter):

Reduces the unwanted effects of random FM noise pulses caused by channel fading under high Signal-to-Noise (S/N) conditions such as in a moving in a transportation. The fading effects, heard as audio pops and clicks, are cancelled without affecting the desired audio signal.

The Random FM Noise Canceller operates only in receive mode.

Note: This feature must be preprogrammed by a qualified radio technician. Check with your dealer or system administrator for more information.

■ The Global Positioning System (GPS)

This feature uses information from the Global Positioning System (GPS) satellites orbiting the Earth to determine the approximate geographical location of your radio, expressed as latitude and longitude or MGRS format per request from customer. The availability and accuracy of this location information (and the amount of time that it takes to calculate it) varies depending on the environment in which you are using the GPS feature.

For example, GPS location fixes are very difficult to obtain indoors, in covered locations, between high buildings, or in situations where you have not established a clear broad view of the sky.

Understanding the GPS Feature

The GPS technology uses radio signals from earth orbiting satellites, to establish the location coordinates, maximizing your view of clear unobstructed sky is essential for optimum performance.

Where adequate signals from multiple satellites are not available (usually because you cannot establish a view of a wide area of the sky), the GPS feature of your radio will not work. Such situations include but are not limited to:

- Underground locations

- Inside of buildings, trains, or other covered vehicles
- Under any other metal or concrete roof or structure
- Between tall buildings or under dense tree-cover
- In temperature extremes outside the operating limits of your radio

Even where location information can be calculated in such situations, it may take longer to do so, and your location estimate may not be as accurate. Therefore, in any emergency situation, always report your location to your dispatcher.

Note: Even where adequate signals from multiple satellites are available, your GPS feature only provides an approximate location, usually within 20 meters from your actual location, but sometimes further away.

Keep in mind that the accuracy of the location information and the time it takes to obtain it varies depending upon circumstances, particularly the ability to receive signals from an adequate number of satellites.

Note: The satellites used by the GPS feature are controlled by the U.S. government and are subject to changes implemented in accordance with the Department of Defense GPS user policy and the Federal Radio Navigation Plan. These changes may affect the performance of the GPS feature on your radio.

Enhancing GPS Performance

Sometimes, the GPS feature may be unable to complete a location calculation successfully. You then see a message indicating that your radio cannot connect to enough visible satellites.

To maximize the ability of your radio to determine a fix, please note the following guidelines:

- For your initial fix, hold the radio in the face position.
- Stay in the open. The GPS feature works best where there is nothing between your radio and a large amount of open sky.

The Outdoor Location Feature (Using GPS)

This feature allows you to determine your current location using a location menu, as well as your current distance and bearing in relation to another location. Radio location may be requested and reported over-the-air.

Your radio stores up to a maximum of sixty (60) programmable location coordinates, also known as waypoints. When the memory is full, the next waypoints automatically replaces the oldest waypoints in the radio.

The radio also stores four (4) preprogrammed waypoints. These coordinates **cannot** be deleted.

Programmable Waypoints	Preprogrammed Waypoints
User-configurable location coordinates.	Fixed location coordinates: <ul style="list-style-type: none">• Home• Emergency• Last Known Location• Destination
Coordinates can be deleted one at a time, or all at once.	Coordinates cannot be deleted.

Note: The radio automatically exits the feature, if the feature inactivity timer is enabled, when the radio is left idle and the timer expires. You will hear the Menu Inactive Exit Tone upon feature exit.

Enabling MGRS Coordinates

This feature can only be enabled through CPS configuration. When the MGRS coordinate is enabled, all location coordinates are displayed in MGRS format, including the editable locations in GPS.

Accessing the Outdoor Location Feature



Note: An **ON** menu key may be present on the location menu if it is preprogrammed by the dealer or system administrator.

Procedure:

Press the preprogrammed **GPS** button to toggle the Outdoor Location feature on or off.



OR

Follow the procedure below.

- 1  or  to **Loc**.

- 2 Press the **Menu Select** button directly below **Loc**.

- 3 The display shows **Location off**.

- 4 Press the **Menu Select** button directly below **On** to obtain a location fix.
OR
Press the **Menu Select** button directly below **Optn**.
 or  to **Turn On GPS** and press the **Menu Select** button directly below **Sel**.

- 5 The front display shows the MGRS or latitude/longitude location, time and date of the last successful location fix.

6 Press the **Menu Select** button directly below **Rfsh** to obtain a new location fix.

7 The top line temporarily displays **Please wait** while the new location is being determined.
While the new location is being determined, the location signal can be a solid or blinking icon.

8 Once the location coordinates are fixed, the display shows the current latitude and longitude, along with the UTC (Zulu) time and date that the location fix was obtained.
The location coordinates are updated automatically every five seconds while the location signal is present.

OR

If the radio fails to get a location fix, the display shows **No service** and returns to the previous display.

9 Press the **Menu Select** button directly below **Exit** to exit the feature and return to the main screen.

OR

Press , the **PTT** button, or the preprogrammed **GPS** button to return to the Home screen.

The radio also exits the menu if the emergency button is pressed.

Saving a Waypoint

Procedure:

While in the current location display:

- 1 Press the **Menu Select** button directly below **Optn.**

- 2 **▲** or **▼** to **Save as Waypt** and press the **Menu Select** button directly below **Sel.**
OR
▲ or **▼** to **Save as Home** and press the **Menu Select** button directly below **Sel.**
OR
▲ or **▼** to **Save as Dest.** and press the **Menu Select** button directly below **Sel.**

- 3 The display shows **Current loc saved as <Waypoint name>**.
OR
The display shows **Current loc saved as [Home]**.
OR
The display shows **Current loc saved as [Destination]**.

- 4 Press the **Menu Select** button directly below **Exit** to exit the feature and return to the main screen.
OR
Press **⏠**, the **PTT** button, or the preprogrammed **GPS** button to return to the Home screen.

Viewing a Saved Waypoint

Procedure:

While in the current location display:

- 1 Press the **Menu Select** button directly below **Optn.**

- 2 **▲** or **▼** to **Waypoints** and press the **Menu Select** button directly below **Sel.**

- 3 The display shows a list of waypoints.

- 4 **▲** or **▼** to scroll through the list.
OR
▲ or **▼** to select a waypoint to view the location information in full.

- 5 Press the **Menu Select** button directly below **Optn.**

- 6 **▲** or **▼** to **View** and press the **Menu Select** button directly below **Sel** to view the MGRS or latitude/longitude location, time and date of the selected waypoint.

- 7 Press the **Menu Select** button directly below **Back** to return to the previous screen.
OR
Press **⏠**, the **PTT** button, or the preprogrammed **GPS** button to return to the Home screen.

Deleting a Single Saved Waypoint

Procedure:

While in the current location display:

- 1 Press the **Menu Select** button directly below **Optn.**

- 2 **▲** or **▼** to **Waypoints** and press the **Menu Select** button directly below **Sel.**

- 3 The display shows a list of waypoints.

- 4 **▲** or **▼** to the required saved waypoint, and press the **Menu Select** button directly below **Optn.**
▲ or **▼** to **Edit name** and press the **Menu Select** button directly below **Del.**
OR
 Press the **Menu Select** button directly below **Del.**

- 5 The display shows **Delete <Waypoint name> Confirm?**

- 6 Press the **Menu Select** button directly below **Yes** to delete the waypoint.
OR
 Press the **Menu Select** button directly below **No** to return to the Waypoints main screen.

- 7 The display shows momentary **<Waypoint name> deleted** before the radio returns to the Waypoints main screen.

Deleting All Saved Waypoints

Procedure:

While in the current location display:

- 1 Press the **Menu Select** button directly below **Optn.**

- 2 **▲** or **▼** to **Waypoints** and press the **Menu Select** button directly below **Sel.**

- 3 The display shows a list of waypoints.

- 4 **▲** or **▼** to a saved waypoint, and press the **Menu Select** button directly below **Optn.**

- 5 **▲** or **▼** to **Delete All** and press the **Menu Select** button directly below **Sel.**

- 6 The display shows **Delete All saved waypnts Confirm?**

- 7 Press the **Menu Select** button directly below **Yes** to delete all waypoints.
OR
 Press the **Menu Select** button directly below **No** to return to the Waypoints main screen.

- 8 The display shows momentary **All saved waypnts deleted** before the radio returns to the Waypoints main screen.

You cannot delete any of the preprogrammed waypoints.

Measuring the Distance and Bearing from a Saved Waypoint

Procedure:

While in the current location display:

- 1** Press the **Menu Select** button directly below **Optn.**

- 2** ▲ or ▼ to **Dist frm here** and press the **Menu Select** button directly below **Sel.**

- 3** The display shows a list of waypoints.

- 4** ▲ or ▼ to the required waypoint, and press the **Menu Select** button directly below **Sel.**

- 5** The display shows the distance and bearing from the current to the selected coordinates.

Using the Location Feature While in Emergency Mode

When the Emergency feature is activated by pressing the emergency button, the radio exits the Location menu and returns to the Home (default) screen so that you can see which channel the emergency signal is going out on.

However, you may re-enter the Location menu while still in emergency mode, provided that Silent Emergency has not been activated.

If you have turned Location off using the **ON/OFF** menu key, it automatically turns back on when Emergency is activated.

If there is a solid location signal during Emergency, the current location and the location information received is saved as Emergency and Last Known Location waypoints, respectively.

■ Trunking System Controls

📄 Using the Failsoft System

The failsoft system ensures continuous radio communications during a trunked system failure. If a trunking system fails completely, the radio goes into failsoft operation and automatically switches to its failsoft channel.

Procedure:

- 1 During failsoft operation, your radio transmits and receives in conventional operation on a predetermined frequency.
- 2 You hear a medium-pitched tone every 10 seconds and the display shows **Failsoft**.

When the trunking system returns to normal operation, your radio automatically leaves failsoft operation and returns to trunked operation.

📄 Going Out of Range

When your radio goes out of the range of the system, it can no longer lock onto a control channel.

Procedure:

- 1 You hear a low-pitched tone.
AND/OR
The display shows the currently selected zone/channel combination and **Out of range**.
- 2 Your radio remains in this out-of-range condition until:
It locks onto a control channel.
OR
It locks onto a failsoft channel.
OR
It is turned off.

📄 Using the Site Trunking Feature

If the zone controller loses communication with any site, that site reverts to site trunking.

The display shows the currently selected zone/channel combination and **Site trunking**.

Note: When this occurs, you can communicate only with other radios within your trunking site.

Locking and Unlocking a Site



This feature allows your radio to lock onto a specific site. This feature should be used with caution, since it inhibits roaming to another site in a wide-area system.

Procedure:

Use the preprogrammed **Site Lock/Unlock** button to toggle the lock state between locked and unlocked.

OR

Follow the procedure below.

- 1  or  to **Site**.
- 2 Press the **Menu Select** button directly below **Site**.
- 3 Press the **Menu Select** button directly below **Lock** to lock the site. The display shows **Site locked**.
OR
Press the **Menu Select** button directly below **Unlk** to unlock the site. The display shows **Site unlocked**.
- 4 The radio saves the new site lock state and returns to the Home screen.

Viewing and Changing a Site

This feature allows you to view the name of the current site or forces your radio to change to a new one.

Viewing the Current Site

Procedure:

- 1 Press the preprogrammed **Site Displ/Srch** button.
- 2 The display momentarily shows the name of the current site and its corresponding received signal strength indicator (RSSI).

Changing the Current Site

Procedure:

- 1 Press and hold down the preprogrammed **Site Displ/Srch** button.
- 2 You hear a tone and the display shows momentary **Scanning site**.
- 3 When the radio finds a new site, it returns to the Home screen.

■ Mission Critical Wireless

- Bluetooth® -

Note: The use of this feature requires the "Full Feature" expansion board together with the Bluetooth Software.

This feature allows your radio to extend its functionality by connecting to external proprietary Motorola Accessories.

The default setting for Bluetooth-enabled radio is Bluetooth ON. See **Turning the Bluetooth Off** on page 88 to turn the Bluetooth OFF.

Note: Your radio must be preprogrammed to allow you to use this feature.

📄 Turning the Bluetooth On

Procedure:

- 1 **←** or **→** to **BT**. Press the **Menu Select** button directly below BT to access the Bluetooth feature screen.
- 2 **▲** or **▼** to **Status** and press the **Menu Select** button directly below **On**. The display shows **Status On**, and **⌘** appears to indicate Bluetooth is on.
OR
The display shows **Bluetooth on failed** to indicate Bluetooth has failed to launch.
- 3 Press the **Menu Select** button directly below **Exit** to return to the Home screen.

OR

- 1 Press the preprogrammed button to turn the Bluetooth on.
- 2 You hear a short, medium-pitched tone. The display shows momentary **Bluetooth on**, and **⌘** appears to indicate Bluetooth is on.
OR
The display shows **Bluetooth on failed** to indicate Bluetooth has failed to launch.

Turning the Bluetooth Off

Procedure:

- 1 **←** or **→** to **BT**. Press the **Menu Select** button directly below **BT** to access the Bluetooth feature screen.
- 2 **▲** or **▼** to **Status** and press the **Menu Select** button directly below **Off**. The display shows **Status Off**, and **⌘** disappears.
- 3 Press the **Menu Select** button directly below **Exit** to return to the Home screen.

OR

- 1 Press the preprogrammed button to turn the Bluetooth off.
- 2 You hear a short, medium-pitched tone. The display shows momentary **Bluetooth off**, and **⌘** disappears.

Re-Pair Timer

There are two options for configuring the radio's Bluetooth pairing type. The type defines the duration the radio and the accessory retain the pairing information.

- **Immediate** – (For headset and PTT only.) When the radio and/or device is turned off after pairing, the keys are lost. Due to this, when your radio and your device are turned back on, they are unable to re-connect. The user must re-pair the devices to re-establish a new set of pairing keys. See **Pairing Bluetooth Device with the Radio** on page 90.
- **Infinite** – (For headset, PTT and data devices.) When the radio and/or device are turned off after pairing, keys are NOT lost. When the radio and the device are turned back on, they can resume the Bluetooth connection without user intervention.

Re-Pair Timer Options	Re-Pair Timer Scenarios
Immediate (for headset and PTT only)	<ul style="list-style-type: none"> When the radio is powered OFF, pairing key is lost immediately, and accessory attempts to pair again. If pairing is unsuccessful within the Drop Timer value, the accessory automatically powers OFF. When the accessory is powered OFF, all keys are lost immediately, and the user must re-pair the devices. When the devices lose Bluetooth connection, the devices will attempt to re-establish Bluetooth Connection within the Drop Timer value.
Infinite (for headset, PTT and data devices)	<ul style="list-style-type: none"> When the radio is powered OFF, the accessory attempts to re-establish the Bluetooth Connection for a period of time depending upon the Drop Timer value. If the devices fails to reconnect within the period, the accessory then powers OFF.

Bluetooth Drop Timer

The Bluetooth Drop Timer has two different settings and functions, depending upon the selection of the Re-Pair Timer.:

Re-Pair Timer Options	Drop Timer Options
Immediate (for headset and PTT only)	<p>0 – 15 minutes programmable buffer time to re-establish the Bluetooth Connection when the Bluetooth signal is out of range.</p> <p>If either device powers OFF, the pairing keys are immediately cleared from both devices and the devices must re-pair.</p>
Infinite (for headset, PTT and data devices)	<p>This Timer only applies to the accessory. The programmable timer choices are: 0 – 15 minutes, 2 hours, 4 hours or 8 hours.</p> <p>This is a "stay alive" time that the accessory will remain ON without the devices re-connecting before powering off. The radio will remain ON until the user powers the Radio OFF. The radio and accessory will remain paired indefinitely. Once the devices re-connect, the timer is reset.</p>

Check with your dealer or system administrator for more information about these timers.

See **Pairing Bluetooth Device with the Radio** on page 90 to establish the Bluetooth Connection.

Pairing Bluetooth Device with the Radio

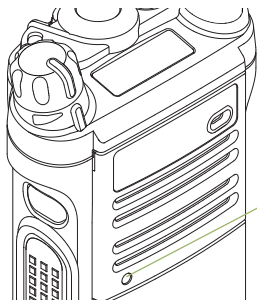

Bluetooth
Pairing
Location

The range of Bluetooth operation is 10 meters line-of-sight communication. This is an **unobstructed** path between the location of the signal transmitter (your radio) and the location of the receiver (your device or accessory).

Obstacles that can cause an obstruction in the line-of-sight include trees, buildings, mountains, cars and etc.



It is **NOT** recommended that you leave your radio behind and expect your accessory to work with a high degree of reliability when they are separated.

At the fringe areas of reception, both voice and tone quality will start to sound "garbled" or "broken". To correct this problem, simply position the accessory and radio closer to each other (within the 10 meter defined range) to re-establish clear audio reception.

Procedure:

Note: Bluetooth tones, Bluetooth menu and Preprogrammed buttons must be preprogrammed by a qualified radio technician. Check with your dealer or system administrator for more information.

With your radio's Bluetooth feature ON, and the Bluetooth tones enabled:

- 1 Turn on the accessory, then place it close to your radio aligning the Bluetooth Pairing Location on the radio to the blue dot-pairing indicator on the accessory.
- 2 If the pairing process is successful, you hear an incremental-pitched tone to indicate paired.
OR
If the pairing process fails, you hear a short, low-pitched tone. The display shows **Bluetooth pairing failed**. Repeat step 1 again.
- 3 The radio continues to connect to the device.
If the connecting process is successful, you hear an incremental-pitched tone. The display shows **<Device Type> connected**, and the Bluetooth icon turns from  to .
OR
If the device already has pairing records and the connecting process fails, you hear a short, low-pitched tone. The display shows **<Device Type> connect failed**. Repeat step 2 to reconnect the Bluetooth device.



OR

If the connecting process is immediately following the pairing process and the connecting process fails to complete within the 6 seconds, you hear a decremental-pitched tone to indicate unpaired. The display shows **<Device Type> unpaired**. Repeat step 1 to re-initiate the pairing process.



Indicating Bluetooth Connection is Lost

The radio shows  when the devices have a Bluetooth connection. Below is the scenario and radio indications when the connection is interrupted.

Procedure:





- 1 The  starts blinking for up to 10 seconds. You hear a decremental-pitched tone and the display shows **<Device Type>** alternating with **disconnected**.
- 2 If the Bluetooth device fails to re-connect within 10 seconds, the display shows momentary **<Device Type> connected**, and  stops blinking.

OR

If the Bluetooth device fails to re-connect within 10 seconds, the blinking  is replaced by a persistent .

Turning On the Bluetooth Audio (Routing the Audio from the Radio to the Headset)

Procedure:

- 1  or  to **BT**. Press the **Menu Select** button directly below **BT** to access the Bluetooth feature screen.
 - 2  or  to **Bluetooth spkr** and press the **Menu Select** button directly below **On**. The display shows **On**.
 - 3 Press the **Menu Select** button directly below **Exit** to return to the Home screen.
-

OR

- 1 Press the preprogrammed button to route the audio routing from the radio to the headset.
 - 2 You hear a short, medium-pitched tone. The display shows **Headset on**.
-

Turning Off the Bluetooth Audio (Routing the Audio from the Headset to the Radio)

Procedure:

- 1 **←** or **→** to **BT**. Press the **Menu Select** button directly below **BT** to access the Bluetooth feature screen.
- 2 **▲** or **▼** to **Bluetooth spkr** and press the **Menu Select** button directly below **Off**. The display shows **Off**.
- 3 Press the **Menu Select** button directly below **Exit** to return to the Home screen.

OR

- 1 Press the preprogrammed button to route the audio routing from the headset to the radio.
- 2 You hear a short, medium-pitched tone. The display shows **Speaker on**.

Adjusting the Volume of the Radio from Bluetooth Audio Device

Procedure:

With the Bluetooth audio device connected to the radio:

- 1 Adjust volume up/down on the bluetooth audio device.
- 2 The radio display shows **Volume XX** and you hear a short, medium-pitched tone.

Viewing and Clearing the Bluetooth Device Information

Procedure:

- 1 **←** or **→** to **BT**. Press the **Menu Select** button directly below **BT** to access the Bluetooth feature screen.
- 2 **▲** or **▼** to **Devices**. Once you toggle the highlight to **Devices** the display shows **XX connected** alternates with **XX paired**. Press the **Menu Select** button directly below **Sel** to see the details.
- 3 The display shows **No devices** if there are no active Bluetooth devices being paired or connected.
OR
If there are devices being paired or connected, **▲** or **▼** along the **<Device Friendly Name>** to see the status of each device.
OR

Press the **Menu Select** button directly below **Back** to return to the previous screen.

- 4 ▲ or ▼ to the required device, press the **Menu Select** button directly below **Clr**.
- 5 The display shows **<Device Friendly Name> clear?**.
- 6 Press the **Menu Select** button directly below **Yes** to proceed.
OR
Press the **Menu Select** button directly below **No** to return to previous screen.
- 7 The display shows **<Device Friendly Name> cleared** to indicate clearing is successful.
OR
You hear the radio sounds a short, low-pitched tone. The display shows **<Device Friendly Name> clear failed**. The display returns to previous screen.
- 8 Press the **Menu Select** button directly below **Back** to return to the previous screen.

Note: If Re-Pair Timer is set to infinite and you clear keys on the radio, you must clear keys on all previously paired devices as well. (Please see your accessories manual for further details.)

Clearing All Bluetooth Devices Information

Procedure:

Long press the preprogrammed Bluetooth On/Off button. You hear a short, medium-pitched tone. Proceed to step 3.

OR

In the Bluetooth feature screen:





- 1 ▲ or ▼ to **Devices** and press the **Menu Select** button directly below **Clr** to clear all active Bluetooth devices. You hear a short, medium-pitched tone.
- 2 The display shows **Clear all BT devices?**. Press the **Menu Select** button directly below **Yes** to proceed.
- 3 The display shows **Please wait** to indicate clearing is in progress.
- 4 The display shows **All BT devices cleared** to indicate clearing is successful.
OR
You hear the radio sounds a short, low-pitched tone. The display shows **Clear all BT devices failed**. The display returns to Bluetooth feature screen.

Note: If Re-Pair Timer is set to infinite and you clear keys on the radio, you must clear keys on all previously paired devices as well. (Please see your accessories manual for further details.)

Viewing the Bluetooth Friendly Name

Note: Your radio must be preprogrammed to allow you to use this feature.

Procedure:

- 1  or  to **BT**. Press the **Menu Select** button directly below **BT** to access the Bluetooth feature screen.
- 2  or  to **Friendly Name**. The display shows **Friendly name** and the preprogrammed **<Bluetooth Friendly Name>**.

■ Programming Over Project 25 (POP 25) (ASTRO 25 and ASTRO Conventional)

This feature enables configuration data to be upgraded to your radio over-the-air. This feature retains full use of the radio during the configuration data transfer without interrupting communication. The upgrade pauses to give priorities to voice call, and continues after the voice call ended.

Once a configuration upgrade is downloaded to your radio, you can install new changes immediately or delay changes to be installed on the radio when it is being powered up. Your radio can also be configured to allow you to accept or reject an upgrade.

Note: This feature must be preprogrammed by a qualified radio technician. Check with your dealer or system administrator for more information.

Responding to the notification of Upgrade

Procedure:

- 1 The display shows **Upgrade?**.

- 2 Press the **Menu Select** button below **Acpt** to accept the request to upgrade immediately. The display shows **Upg Rx In Prog** to indicate the upgrade received is in progress.
OR
 Press the **Menu Select** button below **Dlay** to delay the request to upgrade. The radio prompts to upgrade in the next power up of your radio.
OR
 Press the **Menu Select** button below **Rej** to reject the request to upgrade. The display shows **Upg Aborted**. The radio continues to function with the current configuration until it gets reprogrammed.

- 3 If the upgrade is successful, the display shows **Program done**.
OR
 If the upgrade failed, the display shows **Program failed**. The radio remains in current configuration.

If your radio has problem of upgrade over-the-air, consult the qualified technician for details.

■ Utilities

Viewing the Recent Calls

This feature allows you to view the recent incoming and outgoing call information of the following call types:

- Call Alert
- Selective Call
- Private Call
- Phone Call (Outgoing Only)
- Emergency Call (Incoming Only)



Note: The radio can also be preprogrammed to log only the radio IDs associated with incoming Dispatch Calls. Check with your dealer or system administrator for more information.

Procedure:



Press the preprogrammed **Recent Calls** button and proceed to Step 3.

OR

Follow the procedure below.

- 1  or  to **Rcnt.**

 - 2 Press the **Menu Select** button directly below **Rcnt** to access the **Recent Calls** feature screen.

 - 3  or  to scroll through the list.

 - 4 Press the **Menu Select** button directly below **Exit** to return to the Home screen.
- OR**
Press  or the **PTT** button to return to the Home screen.

The radio automatically exits the feature, if the feature inactivity timer is enabled, when the radio is left idle and the timer expires. You will hear the Menu Inactive Exit Tone upon feature exit.

Using the Flip Display

This feature allows you to reverse the content of the top display upside down. It is particularly useful when you would like to read the top display while the radio is still in the carry holder attached to your belt.

Procedure:

Press and hold the preprogrammed **Light/Flip** button to reverse the display.

Selecting a Basic Zone Bank

This feature allows twice as many zones to be accessed from a switch, doubling the amount of switch positions.

Note: The Basic Zone Select feature must be preprogrammed to the 3-position A-B-C switch, while the Basic Zone Bank feature must be preprogrammed to any side button or **Top (Orange)** button before you can use this feature.

Procedure:

- 1 Use the preprogrammed **Basic Zone Bank** button to toggle the position between Bank 1 and Bank 2.

- 2 The top display shows the status icons (**A, B, C, D, E** or **F**) or the zone name based on the bank and switch position selected.

See **Basic Zone Bank 1** and **Basic Zone Bank 2** on page 17 for more information on the status icons.

Selecting an Enhanced Zone Bank

This feature is created in order to allow users to communicate in more zones. An **Enhanced Zone Bank (EZB)** consists of three zones. This also means each icon **A, B, C, ... or Y** consist of three zones. You can use the preprogrammed 3-position A-B-C switch to select the first, second or third zone in an EZB.

This feature allows user to navigate from up to 75 zones in 25 EZBs.

Note: The Zone Select feature must be preprogrammed to the 3-position A-B-C switch, while the Enhanced Zone Bank feature must be preprogrammed to any side button or **Top (Orange)** button before you can use this feature.

Procedure:

1 Press the preprogrammed **EZB Up** or **EZB Down** button to scroll the EZB up or down.

OR

Press and hold the preprogrammed **EZB Up** or **EZB Down** button to fast scroll the EZB up or down.

2 Turn the 3-Position A/B/C Switch to select the first, second or third zone in the selected EZB.

Selecting the Power Level

This feature enables you to reduce the transmit power level for specific case that require a lower power level. You can select the power level at which your radio transmits. The radio always turns on to the default setting.

Note: Please refer to your agent or qualified radio technician to enable or disable this feature.

These reduced transmit power level settings do not affect your radio's receiving performance, nor diminish the overall quality of ther adio's audio and data functionality given the following conditions.

Settings:



- Select **Low** for a shorter transmitting distance and to conserve power.
- Select **High** for a longer transmitting distance.

Procedure:

Use the preprogrammed **Transmit Power Level Switch** to toggle the power level between low and high power.

OR

Follow the procedure below.

1  or  to **Pwr.**

2 Press the **Menu Select** button directly below **Pwr.**

- 3 The display shows **Low power** and the low power icon.
OR
The display shows **High power** and the high power icon.
-

Selecting a Radio Profile

This feature allows you to manually switch the visual and audio settings of the radio. The display, backlight, alert tones, and audio settings are defined according to the preprogrammed radio settings of each radio profile.

Please refer to a qualified technician for more information.



Note: The radio automatically exits the feature, if the feature inactivity timer is enabled, when the radio is left idle and the timer expires. You will hear the Menu Inactive Exit Tone upon feature exit.

Procedure:



Use the preprogrammed **Profile** button and proceed to Step 3.

OR

Follow the procedure below.

- 1  or  to **Prfl**.

- 2 Press the **Menu Select** button directly below **Prfl** to access the **Profiles** feature screen.

- 3  or  to scroll through the menu selections.

- 4 Press the **Menu Select** button directly below **Sel** to select the required radio profile.

OR

Press the **Menu Select** button directly below **Exit** to exit the screen without making any changes.

- 5 The radio returns to the Home screen. The profile name on the Home screen indicates the current selected radio profile.
-

Enabling and Disabling the Radio Alias

This feature allows you to display or hide the radio alias (name).

Procedure:

- 1 Press the **Menu Select** button directly below **My ID**.

 - 2 The display shows momentary **Radio ID off**, and the radio alias disappears from the Home screen.
OR
The display shows momentary **Radio ID on**, and the radio alias appears on the Home screen.
-

Selecting the Audio Speaker

This feature allows you to select the speaker route for the radio's audio from either the main or the secondary speaker using the radio profile settings.

Note: Your radio must be preprogrammed to allow you to use this feature.

While both speakers function together with the secondary speaker enhancing intelligibility of the received audio during typical radio operation, each speaker has an independently-tuned frequency response and volume level operation.

The secondary speaker also has a "whisper" mode with a modified volume taper for quieter modes of operation.



Note: If an external speaker or microphone accessory is attached to the radio, neither internal speakers are operational as audio is routed to the accessory.

Procedure:



Use the preprogrammed **Profile** button and proceed to Step 3.

OR

Follow the procedure below.

- 1  or  to **Prfl**.

- 2 Press the **Menu Select** button directly below **Prfl** to access the **Profiles** feature screen.

- 3  or  to scroll through the menu selections.

- 4 Press the **Menu Select** button directly below **Sel** to select the radio profile with the required speaker routing.

OR

Press the **Menu Select** button directly below **Exit** to exit the screen without making any changes.

- 5 The radio returns to the Home screen. The profile name on the Home screen indicates the current selected radio profile.

Controlling the Display Backlight

You can enable or disable the radio's display backlight as needed, if poor light conditions make the display difficult to read.

Depending on how your radio is preprogrammed, you can also maintain a minimum backlight level on the radio's front display.

Note: The backlight setting also affects the Menu Select buttons, the Menu Navigation buttons and the keypad backlighting accordingly.

Procedure:

Press the preprogrammed **Light/Flip** button to toggle the backlight on or off.

OR

Press either the Menu Select or Menu Navigation buttons, or any programmable radio controls or buttons to turn the backlight on.

Note: The backlight remains on for a preprogrammed time before it automatically turns off completely or returns to the minimum backlight level.

The preprogrammed Light/Flip button of the accessories connected to the radio such as Display Remote Speaker Microphone (DRSM) is disabled when the radio is in Night Vision Goggles (NVG) display mode.

Setting Up the Radio Display and Visual Indicators to Suite Night Vision Goggles

During tactical nighttime operations of military entities worldwide, the Night Vision Goggles (NVG) is used to see in the dark. Your radio is 3rd generation NVG compatible. When the radio is in NVG display mode, the radio's front display and top display emit a very low illumination backlight to allow the user to operate the radio with the goggles on.



Caution

REMOVE your **NVG** if you operate the radio in non-NVG compatible display mode.

Wearing the NVG to operate in non-NVG compatible display mode might injure your EYES.

Accessory connected to the radio that is in NVG display mode such as Display Remote Speaker Microphone (DRSM) has its backlight always in OFF state.

Intelligent lighting indicators, TX LED and RX LED are all disabled on both the radio and the connected accessory when the radio is in NVG display mode.

Get familiar with your radio NVG feature and operation before you use it with your Night Vision Goggles.

Procedure:

Use the preprogrammed Profile button and proceed to Step 3.

OR

Follow the procedure below.

- 1 ◀ or ▶ to **Prfl**.

- 2 Press the **Menu Select** button directly below **Prfl** to access the **Profiles** screen.

- 3 ▲ or ▼ to the designated NVG profile.

- 4 Press the **Menu Select** button directly below **Sel** to select the required radio profile.
OR
Press the **Menu Select** button directly below **Exit** to exit the screen without making any changes.

- 5 The radio returns to the **Home** screen with NVG display mode. The profile name on the **Home** screen indicates the current selected radio profile.

Locking and Unlocking the Keypad and Controls

You can lock your radio's keypad, programmable buttons, rotary knobs and switches to avoid inadvertent entry. Check with your dealer or qualified technician for best selection to suite your usage.

Procedure:

- 1 Toggle the preprogrammed **Keypad Lock** button or switch to on.

- 2 The display shows **Kypd/Ctrl Lock**.

- 3 Toggle again to unlock the keypad.

Turning Keypad Tones On or Off

You can enable and disable keypad tones, if needed.

Procedure:

Press the preprogrammed **Keypad Mute** button to turn the tones off or on.

OR

Follow the procedure below.

- 1 ◀ or ▶ to **Mute**.

- 2 Press the **Menu Select** button directly below **Mute**.

- 3 The display shows momentary **Tones off**, indicating that the keypad tones are disabled.

OR

The display shows momentary **Tones on**, and you hear a short tone, indicating that the keypad tones are enabled.

Turning Voice Mute On or Off



You can enable and disable voice transmission, if needed.

Procedure:

Press the preprogrammed **Voice Mute** button to turn the feature off or on.

OR

Follow the procedure below.

- 1  or  to **VMut**.
 - 2 Press the **Menu Select** button directly below **VMut**.
 - 3 The display shows momentary **Voice mute off**, and you hear a short tone, indicating that the feature is disabled.
OR
The display shows momentary **Voice mute on**, and you hear a short tone, indicating that the feature is enabled.
-

Using the Time-Out Timer

This feature turns off your radio's transmitter. You cannot transmit longer than the preset timer setting.

If you attempt to do so, the radio automatically stops your transmission, and you hear a talk-prohibit tone.

The timer is defaulted at 60 seconds, but it can be preprogrammed from 3 to 120 seconds, in 15-second intervals, or it can be disabled entirely for each radio mode, by a qualified radio technician.

Note: You will hear a brief, low-pitched, warning tone four seconds before the transmission times out.

Procedure:

- 1 Hold down the **PTT** button longer than the preprogrammed time. You hear a short, low-pitched warning tone, the transmission is cut-off, and the LED goes out until you release the **PTT** button.
 - 2 Release the **PTT** button. The timer resets.
 - 3 Press the **PTT** button to re-transmit. The time-out timer restarts and the LED lights up solid red.
-

Setting the Time and Date

You can set the time and date for your radio.



Settings:

- The default time setting is a 12-hour clock. The display shows **12:00AM**.
- The AM/PM selection is not available for the 24-hour clock setting.
- The default setting for the domestic date shows **MDY**.

Note: Check with your dealer or system administrator for additional programmable settings for this feature.



Editing the Time and Date



Procedure:

- 1  or  to **Clck**.
- 2 Press the **Menu Select** button directly below **Clck**. The display shows the current setting of the radio.
- 3 Press the **Menu Select** button directly below **Edit**. The first item blinks.

- 4  or  to change the selected item.

OR

 or  one or more times to move to an item you wish to change.

 or  to change the selected item.

OR

Press the **Menu Select** button directly below **Exit** to exit the screen without making any changes and return to the Home screen.

- 5 Press the **Menu Select** button directly below **Ok** once you have finished to save your changes and return to the Home screen.

Press  at any time to return to the Home screen without saving your changes.

Note: If a call arrives while the radio is in the clock-setting menu, the radio exits clock setting and displays the call information. Any changes made before the call is **NOT** saved.

Using the Conventional Squelch Operation Features

This feature filters out unwanted calls with low signal strength or channels that have a higher than normal background noise.

Analog Options

Tone Private Line (PL), Digital Private-Line (DPL), and carrier squelch can be available (preprogrammed) per channel.

Mode	Result
Carrier squelch (C)	You hear all traffic on a channel.
PL or DPL	The radio responds only to your messages.

Digital Options

One or more of the following options may be preprogrammed in your radio. Check with your dealer or system administrator for more information.

Option	Result
Digital Carrier-Operated Squelch (COS)	You hear any digital traffic.
Normal Squelch	You hear any digital traffic having the correct network access code.
Selective Switch	You hear any digital traffic having the correct network access code and correct talkgroup.

Using the PL Defeat Feature

This feature allows you to override any coded squelch (DPL or PL) that might be preprogrammed to a channel. The radio will also unmute to any digital activity on a digital channel.

Procedure:

Place the preprogrammed **PL Defeat** switch in the PL Defeat position. You hear any activity on the channel.

OR

The radio is muted if no activity is present.

Note: When this feature is active, the Carrier Squelch status indicator is displayed.

Using the Digital PTT ID Feature

This feature allows you to see the radio ID (number) of the radio from whom you are currently receiving a transmission. This ID, consisting up to a maximum of eight characters, can be viewed by both the receiving radio and the dispatcher.

Your radio's ID number is also automatically sent every time the PTT button is pressed. This is a per-channel feature. For digital voice transmissions, your radio's ID is sent continuously during the voice message.

Using the Smart PTT Feature (Conventional Only)

Smart **PTT** is a per-personality, programmable feature used in conventional radio systems to keep radio users from talking over other radio conversations.

When smart **PTT** is enabled in your radio, you cannot transmit on an active channel.

If you try to transmit on an active smart-**PTT** channel, you hear an alert tone, and the transmission is inhibited. The LED lights up solid yellow to indicate that the channel is busy.

Three variations of smart **PTT** are available:

Mode	Description
Transmit Inhibit on Busy Channel with Carrier	You cannot transmit if any traffic is detected on the channel.
Transmit Inhibit on Busy Channel with Wrong Squelch Code	You cannot transmit on an active channel with a squelch code or (if secure-equipped) encryption key other than your own. If the PL code is the same as yours, the transmission is not prevented.
Quick-Key Override	This feature can work in conjunction with either of the two above variations. You can override the transmit-inhibit state by quick-keying the radio. In other words, two PTT button presses within the preprogrammed time limit.

IMPRES™ Battery Annunciator

This feature displays the current capacity and charges cycles of your battery when a IMPRES Battery is powering your radio. This feature must be enabled in your radio to see the information.

The information shown are:

- **Rated Capacity** – Percentage of current battery capacity.
- **Remaining Capacity** – Remaining power of the battery in mAh.
- **Estimated Charges** – Number of charges cycles the battery has gone through.

Accessing the Battery Info screen

Procedure:

Use the preprogrammed IMPRES Battery button.

- 1 Press the preprogrammed button.
-
- 2 If a IMPRES Battery is powering your radio, the display shows the detail of the battery.
OR
If a non IMPRES Battery is powering your radio, the display shows **No Battery Data**.
-
- 3 Press the **Menu Select** button directly below **Exit** to return to the Home screen.
-

OR

Use the Options Menu.

- 1 ◀ or ▶ to **Batt.**
- 2 Press the **Menu Select** button directly below **Batt.** The display shows the details of the battery.
- 3 Press the **Menu Select** button directly below **Exit** to return to the Home screen.

 **Accessing the General Radio Information**

Your radio contains information on the following:

- Radio Information
- IP Display
- Control Assignments
- Soft ID (If Enabled)

Note: The radio automatically exits the feature, if the feature inactivity timer is enabled, when the radio is left idle and the timer expires. You will hear the Menu Inactive Exit Tone upon feature exit.

Accessing the Radio Information

This feature displays the following information of your radio:

- Host Version
- Secure Version
- Model Number
- ESN
- Flash Code
- Tuning Version
- Option Board Type (optional)
- Option Board Bluetooth Address (optional)
- Expansion Board Type
- DSP Version
- KG (Secure Algorithm)
- Serial Number
- Flash Size & Type
- RF Band
- Processor Version
- Option Board Serial Number (optional)
- Option Board Software Version (optional)
- Language Pack ID and Version (only when the language of the display is set to non-English)

Note: Press  at any time to return to the Home screen.

Procedure:



Press the preprogrammed **Info** button and proceed to Step 3.

OR

Follow the procedure below.

- 1  or  to **Info**.

- 2 Press the **Menu Select** button directly below **Info**.

- 3  or  to **Radio Info** and press the **Menu Select** button directly below **Sel**.

- 4 The display shows the Information screen.

- 5  or  to scroll through the various information.

OR

Press the **Menu Select** button directly below **Back** to return to the previous screen.

OR

Press  to return to the Home screen.

Viewing the IP Information

This feature displays the device name, IP address, and status of your radio.



Note: The device name of your radio is preprogrammed. Check with your dealer or system administrator for more information.

Procedure:



Press the preprogrammed **Info** button and proceed to Step 3.

OR



Follow the procedure below.

- 1  or  to **Info**.

 - 2 Press the **Menu Select** button directly below **Info**.

 - 3  or  to **IP Info** and press the **Menu Select** button directly below **Sel**.

 - 4 The display shows the IP Info screen.

 - 5  or  to scroll through the various information.
- OR**
- Press the **Menu Select** button directly below **Back** to return to the previous screen.
- OR**
- Press  to return to the Home screen.
-

Viewing the Control Assignments

This feature displays the programmable radio functions assigned to the controls of your radio for the currently selected channel.



See **Programmable Features** on page 11 for more information on the various programmable features of your radio.

Procedure:



Press the preprogrammed **Info** button and proceed to Step 3.

OR



Follow the procedure below.

- 1  or  to **Info**.

 - 2 Press the **Menu Select** button directly below **Info**.

 - 3  or  to **Control map** and press the **Menu Select** button directly below **Sel**.

 - 4 The display shows the Control Map screen.

 - 5  or  to scroll through the various information.
- OR**
- Press the **Menu Select** button directly below **Back** to return to the previous screen.
- OR**
- Press  to return to the Home screen.
-

Voice Announcement

This feature enables the radio to audibly indicate the current feature mode, Zone or Channel the user has just assigned. This audio indicator can be customized per customer requirements. This is typically useful when the user is in a difficult condition to read the content shown on the display.

Each voice announcement is within a limit of three seconds maximum. The sum total duration for all voice announcements in a radio shall be no more than 1000 seconds.

Note: This feature must be preprogrammed by a qualified radio technician.

Check with your agent if Voice Announcement is available for the feature you need.

The two options of priority for the Voice Announcement available are:

- **High** – enables the voice of the feature to announce even when the radio is receiving calls.
- **Low** – disables the voice of the feature from announcing when the radio is receiving calls.

Procedure:

You hear a voice announcement when the features below are preprogrammed in the radio.

- The radio powers up. The radio announces the current zone and channel it is transmitting.
- Press the preprogrammed voice announcement button (which specifically programmed to playback the current zone and channel). The radio announces the current zone and channel it is transmitting.

Note: Pressing this preprogrammed playback button will always enable the voice feature to announce in High priority.

All the three programmable buttons at the side of the radio support this feature.

- Change to a new zone. The radio announces the current zone and channel it is transmitting.
- Change to a new channel remaining within the current zone. The radio announces the current channel.
- Press either the **Menu Select** button or preprogrammed button or switch of the radio to launch or terminate Scan, PL Disabled, Talkaround/Direct or Transmit Inhibit. The radio announces the corresponding feature activation or deactivation.

Helpful Tips

Take a moment to review the following:

Caring for Your Radio	page 111
Cleaning Your Radio	page 112
Handling Your Radio	page 113
Servicing Your Radio	page 113
Taking Care of the Battery	page 114
Checking the Battery Charge Status	page 114
Battery Recycling and Disposal	page 115

Caring for Your Radio



Caution

- The APX 6000/APX 6000Li radio casting has a vent port that allows for pressure equalization in the radio. Never poke this vent with any objects, such as needles, tweezers, or screwdrivers. This could create leak paths into the radio and the radio's submergibility will be lost.

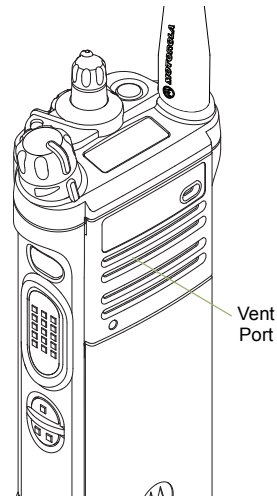

- **(For APX 6000/APX 6000Li R Radios Only)**
The APX 6000/APX 6000Li R radio is designed to be submerged to a maximum depth of 6 feet, with a maximum submersion time of 2 hours. Exceeding either maximum limit may result in damage to the radio.



Caution

- **(For APX 6000/APX 6000Li R Radios Only)** Elastomer technology materials used for seals in rugged portable radios can age with time and environmental exposure. Therefore, Motorola recommends that rugged radios be checked annually as a preventive measure in order to assure the watertight integrity of the radio. Motorola details the disassembly, test, and reassembly procedures along with necessary test equipment needed to inspect, maintain and troubleshoot radio seals in the radio's service manual.
- If the radio battery contact area has been submerged in water, dry and clean the radio battery contacts before attaching a battery to the radio. Otherwise, the water could short-circuit the radio.
- If the radio has been submerged in water, shake the radio well so that any water that may be trapped inside the speaker grille and microphone port can be removed. Otherwise, the water will decrease the audio quality of the radio.
- Do not disassemble the radio. This could damage radio seals and result in leak paths into the radio. Any radio maintenance should be performed only by a qualified radio technician.

Cleaning Your Radio

To clean the external surfaces of your radio:

- 1 Combine one teaspoon of mild dishwashing detergent to one gallon of water (0.5% solution).
- 2 Apply the solution sparingly with a stiff, non-metallic, short-bristled brush, making sure excess detergent does not get entrapped near the connectors, controls or crevices. Dry the radio thoroughly with a soft, lint-free cloth.
- 3 Clean battery contacts with a lint-free cloth to remove dirt or grease.



Caution

Do not use solvents to clean your radio as most chemicals may permanently damage the radio housing and texture.

Do not submerge the radio in the detergent solution.

Handling Your Radio

- Do not pound, drop, or throw the radio unnecessarily. Never carry the radio by the antenna.
- Avoid subjecting the radio to an excess of liquids. Do not submerge the radio unless it is a ruggedized, APX 6000/APX 6000Li R model.
- Avoid subjecting the radio to corrosives, solvents or chemicals.
- Do not disassemble the radio.
- Keep the accessory-connector cover in place until ready to use the connector. Replace the cover immediately once the accessory has been disconnected.
- When charging the radio using a wall mounted charger, the radio must be turned off. Otherwise, the **Man Down Alert and Emergency** may be accidentally triggered.

Servicing Your Radio

Proper repair and maintenance procedures will assure efficient operation and long life for this product. A Motorola maintenance agreement will provide expert service to keep this and all other communication equipment in perfect operating condition. A nationwide service organization is provided by Motorola to support maintenance services. Through its maintenance and installation program, Motorola makes available the finest service to those desiring reliable, continuous communications on a contract basis. For a contract service agreement, please contact your nearest Motorola service or sales representative, or an authorized Motorola dealer.

Express Service Plus (ESP) is an optional extended service coverage plan, which provides for the repair of this product for an additional period of either one or two years beyond the normal expiration date of the standard warranty. For more information about ESP, contact the Motorola Radio Support Center at 3761 South Central Avenue, Rockford, IL 61102 (800) 227-6772 / (847)725-4200.

■ Taking Care of the Battery

☞ Checking the Battery Charge Status

Your radio can indicate the battery's charge status through:

- the LED and sounds.
- the fuel gauge icon on the display.

You can also check the battery charge status via the menu entry. See **IMPRES™ Battery Annunciator** on page 106 for more information.



☞ LED and Sounds





When your battery is low:

- the LED blinks red when the **PTT** button is pressed.
- you hear a low-battery “chirp” (short, high-pitched tone).

☞ Fuel Gauge Icon

A blinking fuel gauge icon () is displayed only when the battery voltage drops to low level. In this case, replace the battery with a fully charged one.

Gauge	Battery Charge
 Top Display	76% to 100% full*
 Top Display	51% to 75%*
 Top Display	26% to 50%*

Gauge	Battery Charge
 Top Display 	11% to 25%*
 Top Display 	10% or less (at 10%, the gauge begins blinking)

*These are for IMPRES battery operation only.

Battery Recycling and Disposal

In the U.S. and Canada, Motorola participates in the nationwide Rechargeable Battery Recycling Corporation (RBRC) program for battery collection and recycling. Many retailers and dealers participate in this program.

For the location of the drop-off facility closest to you, access RBRC's Internet web site at www.rbrc.com or call 1-800-8-BATTERY. This internet site and telephone number also provide other useful information concerning recycling options for consumers, businesses, and governmental agencies.

Appendix: Maritime Radio Use in the VHF Frequency Range

Take a moment to review the following:

Special Channel Assignments	page 116
Operating Frequency Requirements	page 117
Declaration of Compliance for the User of Distress and Safety Frequencies	page 119

■ Special Channel Assignments

Emergency Channel

If you are in imminent and grave danger at sea and require emergency assistance, use **VHF Channel 16** to send a distress call to nearby vessels and the United States Coast Guard.

Transmit the following information, in this order:

- 1 "MAYDAY, MAYDAY, MAYDAY."
- 2 "THIS IS _____, CALL SIGN _____."

State the name of the vessel in distress 3 times, followed by the call sign or other identification of the vessel, stated 3 times.

- 3 Repeat "MAYDAY" and the name of the vessel.
- 4 "WE ARE LOCATED AT _____."

State the position of the vessel in distress, using any information that will help responders to locate you, e.g.:

- latitude and longitude
 - bearing (state whether you are using true or magnetic north)
 - distance to a well-known landmark
 - vessel course, speed or destination
- 5 State the nature of the distress.
 - 6 Specify what kind of assistance you need.
 - 7 State the number of persons on board and the number needing medical attention, if any.
 - 8 Mention any other information that would be helpful to responders, such as type of vessel, vessel length and/or tonnage, hull color, etc.
 - 9 "OVER."
 - 10 Wait for a response.
 - 11 If you do not receive an immediate response, remain by the radio and repeat the transmission at intervals until you receive a response. Be prepared to follow any instructions given to you.

Non-Commercial Call Channel

For non-commercial transmissions, such as fishing reports, rendezvous arrangements, repair scheduling, or berthing information, use VHF Channel 9.

■ Operating Frequency Requirements

A radio designated for shipboard use must comply with Federal Communications Commission Rule Part 80 as follows:

- on ships subject to Part II of Title III of the Communications Act, the radio must be capable of operating on the 156.800 MHz frequency
- on ships subject to the Safety Convention, the radio must be capable of operating:
 - in the simplex mode on the ship station transmitting frequencies specified in the 156.025 – 157.425 MHz frequency band, and
 - in the semiduplex mode on the two frequency channels specified in the table below.

Note: Simplex channels 3, 21, 23, 61, 64, 81, 82, and 83 cannot be lawfully used by the general public in US waters.

Additional information about operating requirements in the Maritime Services can be obtained from the full text of FCC Rule Part 80 and from the US Coast Guard.

Table A-1: VHF Marine Channel List

Channel Number	Frequency (MHz)	
	Transmit	Receive
1	156.050	160.650
2	156.100	160.700

Table A-1: VHF Marine Channel List (Continued)

Channel Number	Frequency (MHz)	
	Transmit	Receive
*	156.150	160.750
4	156.200	160.800
5	156.250	160.850
6	156.300	–
7	156.350	160.950
8	156.400	–
9	156.450	156.450
10	156.500	156.500
11	156.550	156.550
12	156.600	156.600
13**	156.650	156.650
14	156.700	156.700
15**	156.750	156.750
16	156.800	156.800
17**	156.850	156.850
18	156.900	161.500
19	156.950	161.550
20	157.000	161.600
*	157.050	161.650
22	157.100	161.700

Table A-1: VHF Marine Channel List (Continued)

Channel Number	Frequency (MHz)	
	Transmit	Receive
*	157.150	161.750
24	157.200	161.800
25	157.250	161.850
26	157.300	161.900
27	157.350	161.950
28	157.400	162.000
60	156.025	160.625
*	156.075	160.675
62	156.125	160.725
63	156.175	160.775
*	156.225	160.825
65	156.275	160.875
66	156.325	160.925
67**	156.375	156.375
68	156.425	156.425
69	156.475	156.475
71	156.575	156.575
72	156.625	—
73	156.675	156.675
74	156.725	156.725

Table A-1: VHF Marine Channel List (Continued)

Channel Number	Frequency (MHz)	
	Transmit	Receive
75	***	***
76	***	***
77**	156.875	—
78	156.925	161.525
79	156.975	161.575
80	157.025	161.625
*	157.075	161.675
*	157.125	161.725
*	157.175	161.775
84	157.225	161.825
85	157.275	161.875
86	157.325	161.925
87	157.375	161.975
88	157.425	162.025

* Simplex channels 3, 21, 23, 61, 64, 81, 82, and 83 **cannot be lawfully used** by the general public in US waters.

** Low power (1 W) only

*** Guard band

Note: A – in the Receive column indicates that the channel is transmit only.

■ Declaration of Compliance for the User of Distress and Safety Frequencies

The radio equipment does not employ a modulation other than the internationally adopted modulation for maritime use when it operates on the distress and safety frequencies specified in RSS-182 Section 6.1.

Table A-2: Technical Parameters for Interfacing External Data sources

	RS232	USB	SB9600
Input Voltage (Volts Peak-to-peak)	18 V	3.6 V	5 V
Max Data Rate	28 kb/s	12 Mb/s	9.6 kb/s
Impedance	5k Ohm	90 Ohm	120 Ohm

Accessories

The accessory link below is for APX radios. Not all accessories are FCC certified for operation with all APX models and/or bandsplits. Please refer to the specific APX radio price pages for a list of FCC certified accessories or contact your sales representative for accessory compatibility.

<http://www.motorolasolutions.com/APX>

Highlights for the Accessories

- 1 **GPS only antenna** is only used in either a single band UHF or 700/800 application where the Public Safety Microphone (PSM) is used with the corresponding PSM antenna. This antenna is only for GPS reception and cannot be used for receive/transmit operation at UHF, VHF or 700/800. This antenna is never to be used on the PSM.

Glossary



This glossary is a list of specialized terms used in this manual.

Term	Definition
ACK	Acknowledgment of communication.
Active Channel	A channel that has traffic on it.
Analog Signal	An RF signal that has a continuous nature rather than a pulsed or discrete nature.
ARS	Automatic Registration Service
ASTRO 25	Motorola standard for wireless digital trunked communications.
ASTRO Conventional	Motorola standard for wireless digital conventional communications.
Autoscan	A feature that allows the radio to automatically scan the members of a scan list.
Bluetooth	Bluetooth is an open wireless technology standard for exchanging data over short distances from fixed and mobile devices with high levels of security.

Term	Definition
Bluetooth Pairing	Bluetooth pairing occurs when two bluetooth devices exchanged a passkey to form a paired Bluetooth wireless connection.
Call Alert	Privately page an individual by sending an audible tone.
Carrier Squelch	Feature that responds to the presence of an RF carrier by opening or unmuting (turning on) a receiver's audio circuit. A squelch circuit silences the radio when no signal is being received so that the user does not have to listen to "noise".
Central Controller	A software-controlled, computer-driven device that receives and generates data for the trunked radios assigned to it. It monitors and directs the operations of the trunked repeaters.
Channel	A group of characteristics such as transmit/receive frequency pairs, radio parameters, and encryption encoding.
Control Channel	In a trunking system, one of the channels that is used to provide a continuous, two-way/data communications path between the central controller and all radios on the system.

Term	Definition
Conventional	Typically refers to radio-to-radio communications, sometimes through a repeater (see Trunking).
Conventional Scan List	A scan list that includes only conventional channels.
CP	Codeplug
Cursor	A visual tracking marker (a blinking line) that indicates a location on the display.
Digital Private Line (DPL)	A type of coded squelch using data bursts. Similar to PL except a digital code is used instead of a tone.
Digital Signal	An RF signal that has a pulsed, or discrete, nature, rather than a continuous nature.
Dispatcher	An individual who has radio system management duties.
DSP	Digital Signal Processing
Dynamic Regrouping	A feature that allows the dispatcher to temporarily reassign selected radios to a single special channel so they can communicate with each other.
DSR	Dynamic System Resilience
EID	Encrypted Integrated Data
ESN	Electrical Serial Number

Term	Definition
Failsoft	A feature that allows communications to take place even though the central controller has failed. Each trunked repeater in the system transmits a data word informing every radio that the system has gone into failsoft.
FCC	Federal Communications Commission.
FM	Frequency Modulation
Hang Up	Disconnect.
Home screen	The first display information after the radio completes its self test.
IV & D	Integrated Voice and Data
KVL	Key-variable loader: A device for loading encryption keys into the radio.
LCD	Liquid crystal display.
LED	Light-emitting diode.
Li-Ion	Lithium ion.
MDC	Motorola Data Communication

Term	Definition
Man Down	A life-saving feature that senses the radio user may be in trouble by monitoring the whether the radio is in a vertical or horizontal position or whether the radio is motionless. When this feature is triggered, the radio alerts the user with audio and visual alerts. It can also trigger Emergency Alarm if enabled.
Menu Entry	A software-activated feature shown at the bottom of the display – selection of these features is controlled by the  ,  , and  buttons.
Monitor	Check channel activity by pressing the Monitor button. If the channel is clear, you hear static. If the channel is in use, you hear conversation. It also serves as a way to check the volume level of the radio, since the radio “opens the squelch” when the monitor button is pressed.
Multi-System Talkgroup Scan List	A scan list that can include both talkgroups (trunked) and channels (conventional).

Term	Definition
Network Access Code	Network Access Code (NAC) operates on digital channels to reduce voice channel interference between adjacent systems and sites.
NiMH	Nickel-metal-hydride.
Non-Tactical/ Revert	The user talks on a preprogrammed emergency channel. The emergency alarm is sent out on this same channel.
OTAR	Over-the-air rekeying.
Page	A one-way alert, with audio and/or display messages.
Personality	A set of unique features specific to a radio.
PIN	Personal Identification Number
Preprogrammed	Refers to a software feature that has been activated by a qualified radio technician.
Private (Conversation) Call	A feature that lets you have a private conversation with another radio user in the talkgroup.
Private Line (PL)	A sub-audible tone that is transmitted such that only receivers decoding the tone receives it.
Programmable	Refers to a radio control that can have a radio feature assigned to it.

Term	Definition
PTT	Push-To-Talk – the PTT button engages the transmitter and puts the radio in transmit (send) operation when pressed.
Radio Frequency (RF)	The part of the general frequency spectrum between the audio and infrared light regions (about 10 kHz to 10,000,000 MHz).
Repeater	A conventional radio feature, where you talk through a receive/transmit facility that re-transmits received signals, in order to improve communications range and coverage.
Selective Call	A feature that allows you to call a select individual, intended to provide privacy and to eliminate the annoyance of having to listen to conversations of no interest to you.
Selective Switch	Any digital P25 traffic having the correct Network Access Code and the correct talkgroup.
Squelch	Special electronic circuitry, added to the receiver of a radio, that reduces, or cuts off, unwanted signals before they are heard in the speaker.
SSI	Synchronous Serial Interface

Term	Definition
Standby	An operating condition whereby the radio's speaker is muted but still continues to receive data.
Status Calls	Pre-defined text messages that allow the user to send a conditional message without talking.
Tactical/ Non-Revert	The user talks on the channel that was selected before the radio entered the emergency state.
Talkaround	Bypass a repeater and talk directly to another unit for easy local unit-to-unit communications.
Talkgroup	An organization or group of radio users who communicate with each other using the same communication path.
TMS	Text Messaging Service
Trunking	The automatic sharing of communications paths between a large number of users (see Conventional).
Trunking Priority Monitor Scan List	A scan list that includes talkgroups that are all from the same trunking system.
USK	Unique Shadow Key.

Term	Definition
UTC	Coordinated Universal Time. The international time standard (formerly Greenwich Mean Time, or GMT). Zero hours UTC is midnight in Greenwich, England, which is located at 0 degrees longitude. Everything east of Greenwich (up to 180 degrees) is later in time; everything west is earlier. There are 42 time authorities around the world that are constantly synchronizing with each other. Abbreviated as UTC (English backronym = Universal Time, Coordinated), it is also known as Zulu (Z) Time.
Zone	A grouping of channels.

Commercial Warranty

Limited Warranty

MOTOROLA COMMUNICATION PRODUCTS

I. WHAT THIS WARRANTY COVERS AND FOR HOW LONG:

MOTOROLA SOLUTIONS INC. ("MOTOROLA") warrants the MOTOROLA manufactured Communication Products listed below ("Product") against defects in material and workmanship under normal use and service for a period of time from the date of purchase as scheduled below:

ASTRO APX 6000/APX 6000Li Portable Units	One (1) Year
Product Accessories	One (1) Year

MOTOROLA, at its option, will at no charge either repair the Product (with new or reconditioned parts), replace it (with a new or reconditioned Product), or refund the purchase price of the Product during the warranty period provided it is returned in accordance with the terms of this warranty. Replaced parts or boards are warranted for the balance of the original applicable warranty period. All replaced parts of Product shall become the property of MOTOROLA.

This express limited warranty is extended by MOTOROLA to the original end user purchaser only and is not assignable or

transferable to any other party. This is the complete warranty for the Product manufactured by MOTOROLA. MOTOROLA assumes no obligations or liability for additions or modifications to this warranty unless made in writing and signed by an officer of MOTOROLA.

Unless made in a separate agreement between MOTOROLA and the original end user purchaser, MOTOROLA does not warrant the installation, maintenance or service of the Product.

MOTOROLA cannot be responsible in any way for any ancillary equipment not furnished by MOTOROLA which is attached to or used in connection with the Product, or for operation of the Product with any ancillary equipment, and all such equipment is expressly excluded from this warranty. Because each system which may use the Product is unique, MOTOROLA disclaims liability for range, coverage, or operation of the system as a whole under this warranty.

II. GENERAL PROVISIONS:

This warranty sets forth the full extent of MOTOROLA'S responsibilities regarding the Product. Repair, replacement or refund of the purchase price, at MOTOROLA'S option, is the exclusive remedy. THIS WARRANTY IS GIVEN IN LIEU OF ALL OTHER EXPRESS WARRANTIES. IMPLIED WARRANTIES, INCLUDING WITHOUT LIMITATION, IMPLIED WARRANTIES OF MERCHANTABILITY AND FITNESS FOR A PARTICULAR PURPOSE, ARE LIMITED TO THE DURATION OF THIS LIMITED WARRANTY. IN NO EVENT SHALL MOTOROLA BE LIABLE FOR DAMAGES IN EXCESS OF THE PURCHASE PRICE OF THE PRODUCT, FOR ANY LOSS OF USE, LOSS OF TIME, INCONVENIENCE, COMMERCIAL LOSS, LOST PROFITS OR SAVINGS OR OTHER INCIDENTAL, SPECIAL OR

CONSEQUENTIAL DAMAGES ARISING OUT OF THE USE OR INABILITY TO USE SUCH PRODUCT, TO THE FULL EXTENT SUCH MAY BE DISCLAIMED BY LAW.

III. STATE LAW RIGHTS:

SOME STATES DO NOT ALLOW THE EXCLUSION OR LIMITATION OF INCIDENTAL OR CONSEQUENTIAL DAMAGES OR LIMITATION ON HOW LONG AN IMPLIED WARRANTY LASTS, SO THE ABOVE LIMITATION OR EXCLUSIONS MAY NOT APPLY.

This warranty gives specific legal rights, and there may be other rights which may vary from state to state.

IV. HOW TO GET WARRANTY SERVICE:

You must provide proof of purchase (bearing the date of purchase and Product item serial number) in order to receive warranty service and, also, deliver or send the Product item, transportation and insurance prepaid, to an authorized warranty service location. Warranty service will be provided by MOTOROLA through one of its authorized warranty service locations. If you first contact the company which sold you the Product (e.g., dealer or communication service provider), it can facilitate your obtaining warranty service. You can also call MOTOROLA at 1-800-927-2744 US/Canada.

V. WHAT THIS WARRANTY DOES NOT COVER:

- A) Defects or damage resulting from use of the Product in other than its normal and customary manner.
- B) Defects or damage from misuse, accident, water, or neglect.

- C) Defects or damage from improper testing, operation, maintenance, installation, alteration, modification, or adjustment.
- D) Breakage or damage to antennas unless caused directly by defects in material workmanship.
- E) A Product subjected to unauthorized Product modifications, disassembles or repairs (including, without limitation, the addition to the Product of non-MOTOROLA supplied equipment) which adversely affect performance of the Product or interfere with MOTOROLA's normal warranty inspection and testing of the Product to verify any warranty claim.
- F) Product which has had the serial number removed or made illegible.
- G) Rechargeable batteries if:
 - (1) any of the seals on the battery enclosure of cells are broken or show evidence of tampering.
 - (2) the damage or defect is caused by charging or using the battery in equipment or service other than the Product for which it is specified.
- H) Freight costs to the repair depot.
- I) A Product which, due to illegal or unauthorized alteration of the software/firmware in the Product, does not function in accordance with MOTOROLA's published specifications or the FCC certification labeling in effect for the Product at the time the Product was initially distributed from MOTOROLA.
- J) Scratches or other cosmetic damage to Product surfaces that does not affect the operation of the Product.
- K) Normal and customary wear and tear.

VI. PATENT AND SOFTWARE PROVISIONS:

MOTOROLA will defend, at its own expense, any suit brought against the end user purchaser to the extent that it is based on a claim that the Product or parts infringe a United States patent, and MOTOROLA will pay those costs and damages finally awarded against the end user purchaser in any such suit which are attributable to any such claim, but such defense and payments are conditioned on the following:

- A) that MOTOROLA will be notified promptly in writing by such purchaser of any notice of such claim;
- B) that MOTOROLA will have sole control of the defense of such suit and all negotiations for its settlement or compromise; and
- C) should the Product or parts become, or in MOTOROLA's opinion be likely to become, the subject of a claim of infringement of a United States patent, that such purchaser will permit MOTOROLA, at its option and expense, either to procure for such purchaser the right to continue using the Product or parts or to replace or modify the same so that it becomes non-infringing or to grant such purchaser a credit for the Product or parts as depreciated and accept its return. The depreciation will be an equal amount per year over the lifetime of the Product or parts as established by MOTOROLA.

MOTOROLA will have no liability with respect to any claim of patent infringement which is based upon the combination of the Product or parts furnished hereunder with software, apparatus or devices not furnished by MOTOROLA, nor will MOTOROLA have any liability for the use of ancillary equipment or software not furnished by MOTOROLA which is attached to or used in connection with the Product. The foregoing states the entire liability of MOTOROLA with respect to infringement of patents by the Product or any parts thereof.

Laws in the United States and other countries preserve for MOTOROLA certain exclusive rights for copyrighted MOTOROLA software such as the exclusive rights to reproduce in copies and distribute copies of such MOTOROLA software. MOTOROLA software may be used in only the Product in which the software was originally embodied and such software in such Product may not be replaced, copied, distributed, modified in any way, or used to produce any derivative thereof. No other use including, without limitation, alteration, modification, reproduction, distribution, or reverse engineering of such MOTOROLA software or exercise of rights in such MOTOROLA software is permitted. No license is granted by implication, estoppel or otherwise under MOTOROLA patent rights or copyrights.

VII. GOVERNING LAW:

This Warranty is governed by the laws of the State of Illinois, U.S.A.

VIII. FOR AUSTRALIA ONLY:

This warranty is given by Motorola Solutions Australia Pty Limited (ABN 16 004 742 312) of Tally Ho Business Park, 10 Wesley Court. Burwood East, Victoria.

Our goods come with guarantees that cannot be excluded under the Australia Consumer Law. You are entitled to a replacement or refund for a major failure and compensation for any other reasonably foreseeable loss or damage. You are also entitled to have the goods repaired or replaced if the goods fail to be of acceptable quality and the failure does not amount to a major failure.

Motorola Solutions Australia's limited warranty below is in addition to any rights and remedies you may have under the Australian Consumer Law. If you have any queries, please call Motorola Solutions Australia at 1800 457 439. You may also visit our website: http://www.motorola.com/Business/XA-EN/Pages/Contact_Us#support_tab for the most updated warranty terms.



Notes



MOTOROLA

Motorola Solutions, Inc.
1303 East Algonquin Road
Schaumburg, Illinois 60196 U.S.A.

MOTOROLA, MOTO, MOTOROLA SOLUTIONS and the Stylized M logo are trademarks or registered trademarks of Motorola Trademark Holdings, LLC and are used under license. All other trademarks are the property of their respective owners. © 2010–2013 Motorola Solutions, Inc. All rights reserved. June 2013.



68012001080-G

