

Panasonic®

Personal Computer

Model No. **CF-19** series

Operating Instructions - Basic Guide

Getting Started

Introduction.....	2
Description of Parts.....	4
First-time Operation.....	7
Turning On / Turning Off.....	11

Getting Started

Useful Information

Handling and Maintenance.....	12
Installing Software.....	14

Useful Information

Troubleshooting

Troubleshooting (Basic).....	18
------------------------------	----

Troubleshooting

Appendix

LIMITED USE LICENSE AGREEMENT.....	23
Specifications.....	25
LIMITED WARRANTY.....	29

Appendix

Please read these instructions carefully before using this product, and save this manual for future use.

Introduction









Thank you for purchasing this Panasonic product. For optimum performance and safety, please read these instructions carefully.

In these instructions, the names are referred as follows.

Windows 8.1 indicates Windows® 8.1 Operating System.

Windows 7 indicates Windows® 7 Operating System.

■ Terms and illustrations in these instructions

CAUTION :	Conditions that may result in minor or moderate injury.
NOTE :	Useful and helpful information.
Enter :	Press [Enter] key.
Fn + F5 :	Press and hold [Fn] key, and then press [F5] key.
Windows 8.1	
• Display “Charm”:	Align the pointer to the top right (or bottom right) corner of the screen to display Charm menu. Alternatively, flick toward the center of the screen from the right edge or press and hold  (Enter) button.
•  -  :	Click  (Settings) and then click  (Power).
Windows 7	
 (Start) - [All Programs] :	Click  (Start), and then click [All Programs]. You may need to double-click in some cases.
 :	Page in these Operating Instructions or in the Reference Manual.
 :	Reference to the on-screen manuals.

- Some illustrations are simplified to help your understanding and may look different from the actual unit.
- If you do not log on as an administrator, you cannot use some functions or cannot display some screens.
- Refer for the latest information about optional products to the catalogs, etc.
- In these instructions, the names and terms are referred as follows.
 - “Windows® 8.1 Pro 64-bit” as “Windows” or “Windows 8.1”
 - “Windows® 7 Professional 32-bit Service Pack 1” and “Windows® 7 Professional 64-bit Service Pack 1” as “Windows” or “Windows 7”
 - DVD MULTI drive as “CD/DVD drive”
 - Circular media including DVD-ROM and CD-ROM as “discs”
- **Windows 8.1**
Screen messages are explained in [English (United States)].
(Depending on the language preference, some screen messages in these instructions are different from the actual screen messages. For example, [Flight mode] may be displayed instead of [Airplane mode] in some language preference.)

■ Disclaimer

Computer specifications and manuals are subject to change without notice. Panasonic Corporation assumes no liability for damage incurred directly or indirectly from errors, omissions or discrepancies between the computer and the manuals.

■ Trademarks

Microsoft®, Windows®, and the Windows logo are registered trademarks of Microsoft Corporation of the United States and/or other countries.

Intel, Core and PROSet are either registered trademarks or trademarks of Intel Corporation.

SDXC Logo is a trademark of SD-3C, LLC.



Adobe, the Adobe logo and Adobe Reader are either registered trademarks or trademarks of Adobe Systems Incorporated in the United States and/or other countries.

Bluetooth® is a registered trademark owned by Bluetooth SIG, Inc., U.S.A. and licensed to Panasonic Corporation. Names of products, brands, etc., appearing in this manual are trademarks or registered trademarks of their respective own companies.

■ On-screen Manual

For further information about the computer, you can refer to the on-screen manual.

- **Reference Manual**

The Reference Manual contains the practical information to help you fully enjoy the computer's performance.

- **Important Battery Tips**

The Important Battery Tips will provide you with the battery information so that you can use the battery in the optimum condition to obtain longer operation time.

To access the on-screen manuals, follow the steps below.

Windows 8.1

On the Start screen, click the [Manual Selector] tile, and select the on-screen manual.

Windows 7

Double-click [Manual Selector] on the desktop, and select the on-screen manual.

NOTE

- [Contents] tab or [Search] tab is displayed on the left side of the window. Select tab and display the desired item.
-

Description of Parts

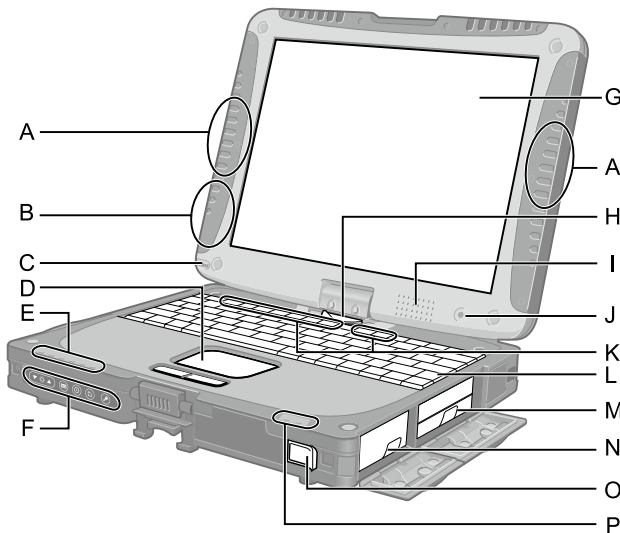

<Model without WWAN Antenna>

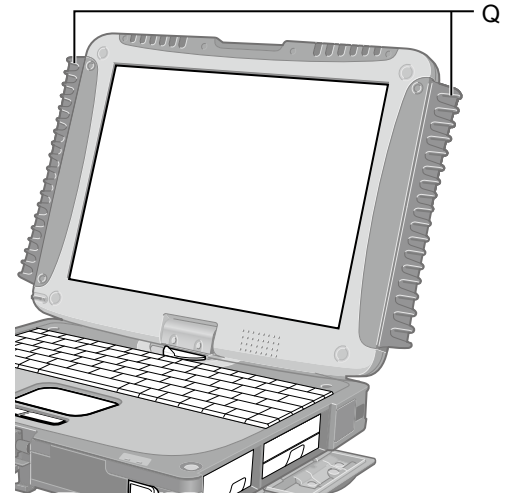

<Model with WWAN Antenna for North America>^{*1}

^{*1} The shape may differ from the illustration depending on the region.

A: Wireless LAN Antenna

<Only for model with wireless LAN>
 → Reference Manual "Wireless LAN"

The wireless LAN switch may turn off depending on the reception.

B: Bluetooth Antenna

<Only for model with Bluetooth>
 → Reference Manual "Bluetooth"

C: Stylus/Digitizer pen Holder

D: Touch Pad

E: LED Indicator

: Wireless ready
 This indicator lights when Wireless LAN, Bluetooth, and/or Wireless WAN are connected and ready. It does not necessarily indicate the On/Off condition of the wireless connection.

→ Reference Manual "Disabling/Enabling Wireless Communication" "Wireless WAN"

: Wireless WAN status
 <Only for model with Wireless WAN>
 → Refer to the instruction manual of the wireless device.

- : Caps lock
- : Numeric key (NumLk)
- : Scroll lock (ScrLk)
- : Hard disk drive status

F: Tablet Buttons

→ Reference Manual "Tablet Buttons"

G: LCD

<Only for model with touchscreen>
 <Only for model with dual touch>
 → Reference Manual "Screen Input Operation"

H: Display Release Latch

→ page 6 "Switching to the Tablet mode"

I: Speaker

→ Reference Manual "Key Combinations"

J: Ambient Light Sensor

Backlight will be turned off with a bright environment so the battery operation time becomes long. It doesn't function when concealing.

→ Reference Manual "Setup Utility"

K: Function Key

→ Reference Manual "Key Combinations"

L: Keyboard

M: Hard Disk Drive

→ Reference Manual "Hard Disk Drive"

N: Battery Pack

Specified Battery pack: CF-VZSU48U

O: Power Switch

P: LED Indicator

: Battery status
 → Reference Manual "Battery Power"

: Power status
 (Off: Power off/Hibernation, Green: Power on, Blinking green: Sleep, Blinking green rapidly: Cannot power on or resume due to low temperature.)

Q: Wireless WAN Antenna

<Only for model with Wireless WAN>
 → Reference Manual "Wireless WAN"

Left side

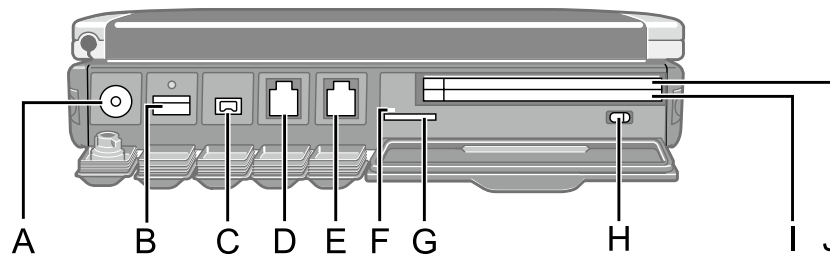

Rear side

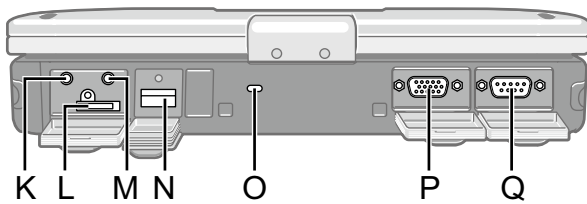

Bottom

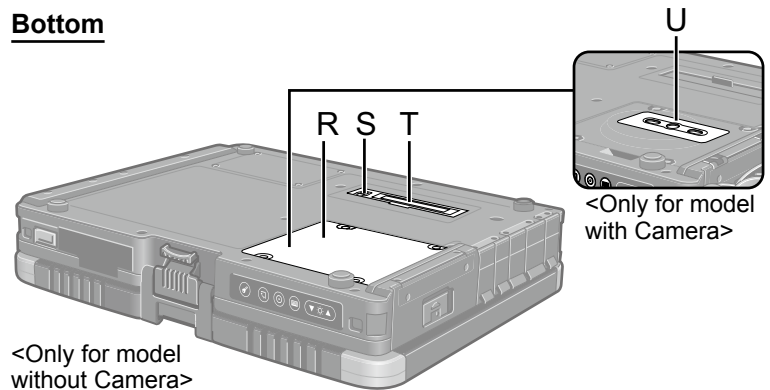

A: DC-IN Jack

B: USB Port (3.0)

→ *Reference Manual* "USB Devices"

C: IEEE 1394 Interface Connector

→ *Reference Manual* "IEEE 1394 Devices"

D: Modem Port

→ *Reference Manual* "Modem"

E: LAN Port

→ *Reference Manual* "LAN"

F: SD Memory Card Indicator

(Blinking: During access)

→ *Reference Manual* "SD Memory Card"

G: SD Memory Card Slot

Keep SD Memory Cards Away from Infants and Small Children.

→ *Reference Manual* "SD Memory Card"

H: Wireless Switch

→ *Reference Manual* "Disabling/Enabling Wireless Communication"

I: <For model without Smart Card Slot>

PC Card Slot (PC)

→ *Reference Manual* "PC Card / ExpressCard"

<For model with Smart Card Slot>

Smart Card Slot (SCR)

→ *Reference Manual* "Smart Card"

J: <For model without Smart Card Slot>

ExpressCard Slot (EX)

→ *Reference Manual* "PC Card / ExpressCard"

<For model with Smart Card Slot>

PC Card Slot (PC)

→ *Reference Manual* "PC Card / ExpressCard"

K: Headphone Jack

You can connect headphones or amplified speakers. When they are connected, audio from the internal speakers is not heard.

L: SIM Card Slot

<Only for model with wireless WAN>

Insert the SIM card into the SIM card slot with the contact side facing down and the cut corner facing forward.

→ *Reference Manual* "Wireless WAN"

M: Microphone Jack

A condenser microphone can be used. If other types of microphones are used, audio input may not be possible, or malfunctions may occur as a result.

N: USB Port (2.0)

→ *Reference Manual* "USB Devices"

O: Security Lock

A Kensington cable can be connected.

For further information, read the manual that comes with the cable.

P: External Display Port (VGA)

→ *Reference Manual* "External Display"

Q: Serial Port

R: RAM Module Slot

<For model without Camera>

→ *Reference Manual* "RAM Module"

S: External Antenna Connector

T: Expansion Bus Connector²

→ *Reference Manual* "Port Replicator / Car Mounter"

U: Camera

<For model with Camera>

Remove the protection seal on the camera before using the camera.

² If you connect this computer to CF-VEB181 series or CF-WEB182 series, you cannot use a keyboard port.

Description of Parts

- This computer contains a magnet and magnetic products at the locations circled in the illustration at right. Avoid leaving metallic object or magnetic media in contact with these areas.

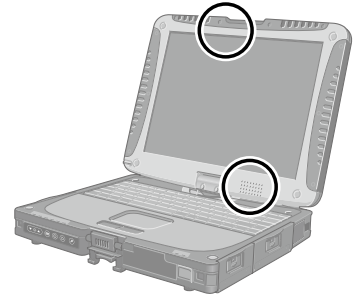

Switching to the Tablet mode

Getting Started

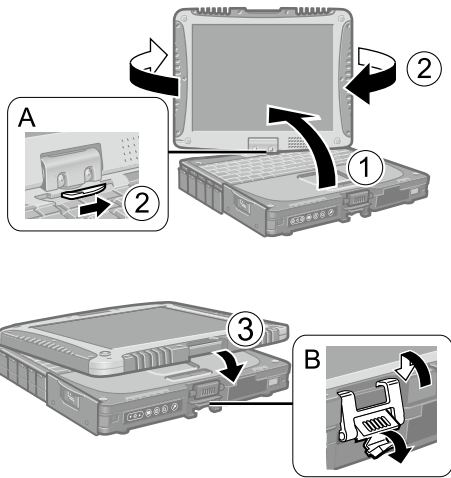

- ① Lift up the display so it stands perpendicular to the body.
- ② Slide the display release latch (A), and rotate the display clockwise until it clicks.

- ③ Close as the display faces up and fix it using the latch (B).

Attaching the hand strap and the shoulder strap (option)

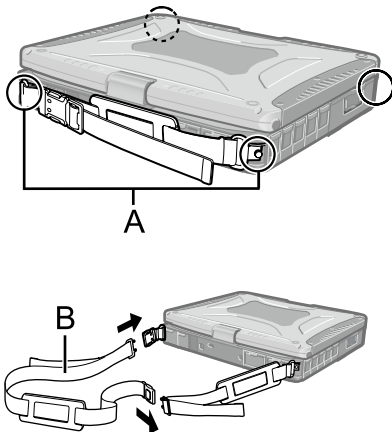

Attach the hand strap to any two of the corners (A) using the screws. You can connect the shoulder strap (B) to the hand strap. (The illustration is an example.)

CAUTION

- Do not use the strap to carry a heavier weight than the computer. Otherwise the strap may become loose by itself.
- Do not use the strap if it becomes worn or damaged.

First-time Operation

■ Preparation

① Check and identify the supplied accessories.

If you do not find the described accessories, contact Panasonic Technical Support (→ page 30).

• **AC Adaptor** 1

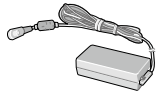

Model No: CF-AA5713A

• **AC Cord** 1



• **Battery Pack** 1

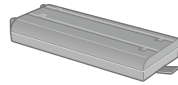

Model No: CF-VZSU48U

<Only for model with touchscreen>
• **Stylus**^{*1} 1



Model No: CF-VNP003U

• **Tether** 1

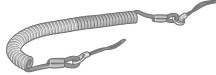

• **Soft Cloth** 1



<Only for model with dual touch>
• **Digitizer pen**^{*1} 1



Model No: CF-VNP012U

→ Reference Manual "Screen Input Operation"

• **OPERATING INSTRUCTIONS - Read Me First** 1

● For model with dual touch, the tether and digitizer pen are already attached to the computer at purchase.

^{*1} Stored in the pen holder at the time of packaging.

② Read the LIMITED USE LICENSE AGREEMENT before breaking the seal on the computer's packaging (→ page 23).

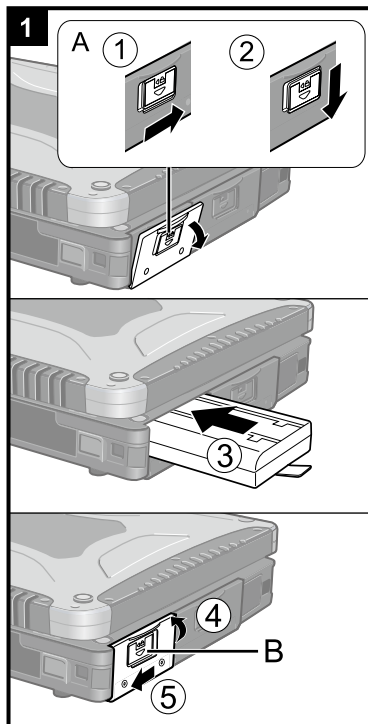

1 Inserting the Battery Pack

- ① Slide the latch (A) to the right to unlock the cover.
- ② Slide the latch (A) down, and open the cover.
- ③ Insert the battery pack until it securely fits the connector.
- ④ Close the cover.
- ⑤ Slide the latch (B) to the left to lock the cover.

CAUTION

- Make sure the latch is securely locked. Otherwise the battery pack may fall when you carry the computer.
- Do not touch the terminals of the battery pack and the computer. Doing so can make the terminals dirty or damaged, and may cause malfunction of the battery pack and the computer.

NOTE

- Note that the computer consumes electricity even when the computer power is off. If the battery pack is fully charged, the battery will fully discharge in the following period of time:
 - When power is off: Approx. 4 weeks
 - In sleep: Approx. 4 days
 - In hibernation: Approx. 2 weeks
- When the DC plug is not connected to the computer, disconnect the AC cord from your electrical outlet. Power is consumed simply by having the AC adaptor plugged into an electrical outlet.

First-time Operation

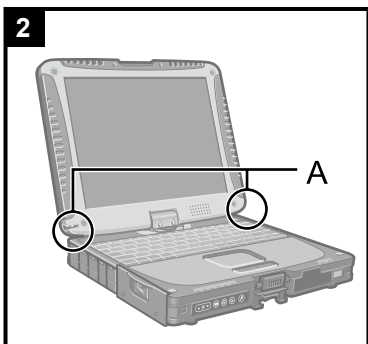

2 Attaching the stylus to the computer

<Only for model with touchscreen>

Use the tether to attach the stylus to the computer so you will not lose it. There are holes (A) to attach it.

- For model with dual touch, the tether and digitizer pen are already attached to the computer at purchase.

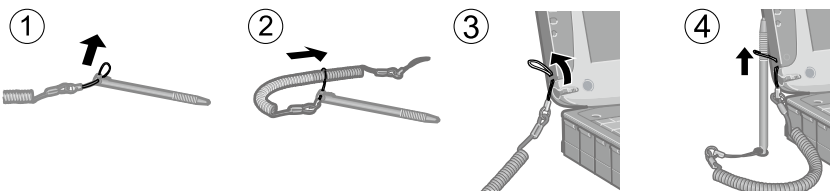

CAUTION

- Do not pull the tether with excessive force. The stylus may hit the computer, person's body or other objects when released.

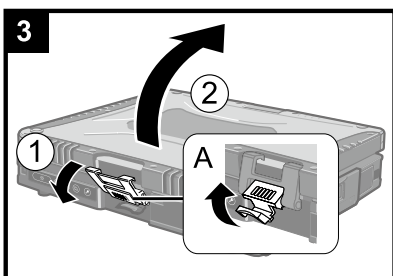

3 Opening the Display

- ① Pull up the part (A) and release the latch.
- ② Lift open the display.

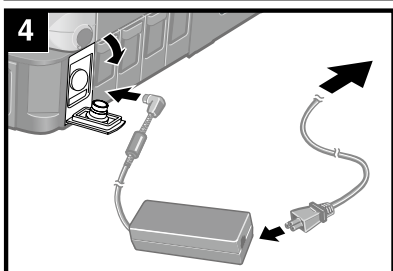

4 Connect your computer to a power outlet.

The battery charging starts automatically.

CAUTION

- Do not disconnect the AC adaptor and do not switch the wireless switch to on until the first-time operation procedure is completed.
- When using the computer for the first time, do not connect any peripheral device except the battery pack and AC adaptor.
- **Handling the AC adaptor**
 - Problems such as sudden voltage drops may arise during periods of thunder and lightning. Since this could adversely affect your computer, an uninterruptible power source (UPS) is highly recommended unless running from the battery pack alone.

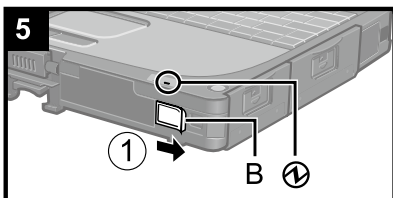

5 Turn on the computer.

- ① Slide and hold the power switch (B) until the power indicator ① lights.

CAUTION

- Do not slide the power switch repeatedly.
- The computer will forcibly be turned off if you slide and hold the power switch for four seconds or longer.
- Once you turn off the computer, wait for ten seconds or more before you turn on the computer again.
- Do not perform the following operation until the drive indicator (cylinder icon) turns off.
 - Connecting or disconnecting the AC adaptor
 - Sliding the power switch
 - Touching the keyboard, touch pad, tablet buttons, touchscreen (only for model with touchscreen), dual touch (only for model with dual touch) or external mouse
 - Closing the display
 - Turn on/off the wireless switch
- When the CPU temperature is high, the computer may not start up to prevent overheating of the CPU. Wait until the computer cools down, and then turn the power on again. If the computer does not power on even after cooling down, contact Panasonic Technical Support (→ page 30).
- Any changes from the default setting of the Setup Utility must not be made until the First-time Operation is completed.

6 Setup Windows.

Follow the on-screen instructions.

- The computer restarts several times. Do not touch the keyboard or touch pad, and wait until the drive indicator  has turned off.
- After the computer is turned on, the screen remains black or unchanged for a while, but this is not a malfunction. Wait for a moment until the Windows setup screen appears.
- During setup of Windows, use the touch pad and clicking to move the pointer and to click an item.
- Setup of Windows will take approximately **Windows 8.1** 5 minutes / **Windows 7** 20 minutes.
Go to the next step, confirming each message on the display.
- You can set the Wireless Network after the setup of Windows is complete.
Windows 8.1 If “Get online” is displayed, select “Skip this step”.
Windows 7 “Join a wireless network” screen may not appear.

CAUTION

- You can change the user name, password, image and security setting after setup of Windows.
- Remember your password. If you forget the password, you cannot use Windows. Creating a password reset disk beforehand is recommended.
- Do not use the following words for user name: CON, PRN, AUX, CLOCK\$, NUL, COM1 to COM9, LPT1 to LPT9, @. In particular, if you create a user name (account name) that includes the “@” mark, a password will be requested at the log-on screen, even if no password has been set. If you try to log on without entering a password, “The user name or password is incorrect.” may be displayed and you will not be able to **Windows 8.1** sign in / **Windows 7** log on to Windows (→ page 20).

7 Create the recovery disc.

A recovery disc allows you to install OS and restore its factory default condition, in case, for example, the recovery partition of the HDD is damaged.

We recommend creating a recovery disc before you begin using the computer. Refer to  *Reference Manual* “Recovery Disc Creation Utility” about creating the disc.

NOTE

● PC Information Viewer

This computer periodically records the management information of the hard disk, etc. The maximum data volume for each record is 1024 bytes.

This information is only used for estimating the cause when the hard disk goes down by any possibility. They are never sent to outside via network nor used for any other purpose except for the purpose described the above.

To disable the function, add the check mark for [Disable the automatic save function for management information history] in [Hard Disk Status] of PC Information Viewer, and click [OK].

(→  *Reference Manual* “Checking the Computer’s Usage Status”)

■ Before using wireless function

- ① Slide the wireless switch to ON.

Windows 8.1



- ② Display “Charm” and click  - [Change PC Settings] - [Network] - [Airplane mode].
Set [Wi-Fi] to [On] (for wireless LAN).
set [Mobile broadband] to [On] (for wireless WAN).
set [GPS] to [On] (for wireless WAN).
set [Bluetooth] to [On] (for Bluetooth).
set [GPS\GNSS] to [On] (for GPS).

First-time Operation

■ To change the partition structure

You can shrink a part of an existing partition to create unallocated disk space, from which you can create a new partition.

In the default setting, you can use a single partition.



- ① **Windows 8.1**
Right-click  at the bottom left corner of the Desktop screen.
Windows 7
Click  (Start) and right-click [Computer], then click [Manage].
 - A standard user needs to enter an administrator password.
- ② Click [Disk Management].
- ③ Right-click the partition for Windows (“c” drive in the default setting), and click [Shrink Volume].
 - The partition size depends on the computer specifications.
- ④ Input the size in [Enter the amount of space to shrink in MB] and click [Shrink].
 - You cannot input a larger number than the displayed size.
 - To select [Reinstall to the OS related partitions.] in installing OS (→ page 15), **Windows 8.1** 70 GB / **Windows 7** 60 GB or more is necessary for [Total size after shrink in MB].
- ⑤ Right-click [Unallocated] (the shrunk space in the step ④) and click [New Simple Volume].
- ⑥ Follow the on-screen instructions to make the settings, and click [Finish].
Wait until formatting is completed.

NOTE

- You can create an additional partition using remaining unallocated space or newly creating unallocated space.
- To delete a partition, right-click the partition and click [Delete Volume] in the step ③.

Turning On / Turning Off

Turning On

Slide and hold the power switch  (→ page 4) until the power indicator  (→ page 4) lights.



NOTE

- Do not slide the power switch repeatedly.
- The computer will forcibly be turned off if you slide and hold the power switch for four seconds or longer.
- Once you turn off the computer, wait for ten seconds or more before you turn on the computer again.
- Do not perform the following operation until the drive indicator  turns off.
 - Connecting or disconnecting the AC adaptor
 - Sliding the power switch
 - Touching the keyboard, touch pad, tablet buttons, screen or external mouse
 - Closing the display
 - Turn on/off the wireless switch

Turning Off

Windows 8.1

You can shut down the computer by using either of the following steps.

- From the Start screen:
 - ① Click  - [Shut down].
- From the Desktop screen:
 - ① Right-click  at the bottom left corner of the Desktop screen.
 - ② Click [Shut down or sign out] - [Shut down].

Windows 7

- ① Click  (Start) - [Shutdown].

NOTE

- **Windows 8.1**

To turn off the computer completely, proceed as follows.

 - ① Display “Charm” and click  - [Change PC settings] - [Update and recovery] - [Recovery].
 - ② Click [Restart now] under “Advanced startup”
 - ③ Click [Turn off your PC].

Precautions against Starting Up/Shutting Down

- Do not do the following
 - Connecting or disconnecting the AC adaptor
 - Sliding the power switch
 - Touching the keyboard, touch pad, screen or external mouse
 - Closing the display
 - Turn on/off the wireless switch

NOTE

- To conserve power, the following power saving methods are set at the time of purchase.
 - The screen automatically turns off after :
 - 10 minutes (when AC adaptor is connected) of inactivity
 - 5 minutes (when operating on battery power) of inactivity
 - The computer automatically enters sleep^{*1} after :
 - 20 minutes (when AC adaptor is connected) of inactivity
 - 15 minutes (when operating on battery power) of inactivity

^{*1} Refer to  *Reference Manual* “Sleep or Hibernation Functions” about resuming from sleep.

Handling and Maintenance

Operation environment

- Place the computer on a flat stable surface not subject to shock, vibration, and danger of dropping. Do not place the computer upright or turn it over. If the computer is exposed to an extremely strong impact, it may become damaged.
 - Operating environment
 - Temperature: Operation : -10 °C to 50 °C {14 °F to 122 °F} (IEC60068-2-1, 2)^{*1}
 - Storage : -20 °C to 60 °C {-4 °F to 140 °F}
 - Humidity: Operation : 30% to 80% RH (No condensation)
 - Storage : 30% to 90% RH (No condensation)
- Even within the above temperature/humidity ranges, operation for a long time in extreme environments, smoking nearby, or operation in places where oil is used or where there is a lot of dust will result in the product deterioration and will shorten the product life.
- ^{*1} Do not expose the skin to this product when using the product in a hot or cold environment. (→ OPERATING INSTRUCTIONS - Read Me First)
- If the computer is wet in temperatures of 0 °C {32 °F} or below, freeze damage may occur. Make sure to dry off the computer in such temperatures.
- Do not place the computer in the following areas, otherwise the computer may be damaged.
 - Near electronic equipment. Image distortion or noise may occur.
 - In extremely high or low temperature.
 - As the computer can become hot during operation, keep it away from items that are sensitive to heat.

Handling cautions

This computer is designed to minimize shock to parts such as the LCD and the hard disk drive and equipped with a drip-proof keyboard, but no warranty is provided against any trouble caused by shock. Be extremely careful when handling the computer.

- When carrying the computer:
 - Turn off the computer.
 - Remove all external devices, cables, PC Cards and other protruding objects.
 - Do not drop or hit the computer against solid objects.
 - Do not leave the display open.
 - Do not grip the display part.
 - Do not put anything (e.g., a piece of paper) between the display and keyboard.
 - When you board an airplane, take the computer with you and never put it in your checked luggage. When using the computer on airplane, follow the airline's instructions.
 - When carrying a spare battery, put it in a plastic bag to protect its terminals.
 - The touch pad is designed to be used by a finger tip. Do not place any object on its surface and do not press down strongly with sharp-pointed or hard objects that may leave marks (e.g., nails, pencils and ball point pens).
 - Avoid any harmful substances such as oil from getting into the touch pad. The pointer may not work correctly.
 - Be careful not to get injured by dropping or getting hit when carrying the computer.
 - Use only the included stylus/digitizer pen to touch the touchscreen. Do not place any object on its surface and do not press down strongly with sharp-pointed or hard objects that may leave marks (e.g., nails, pencils and ball point pens).
 - Do not use the touchscreen when dust or dirt (e.g., oil) is on the screen. Otherwise foreign particles on the screen/stylus/digitizer pen can scratch the screen surface or obstruct the stylus/digitizer pen operation.
 - Use the stylus/digitizer pen only for touching the screen. Using it for any other purpose may damage the stylus/digitizer pen and result in scratches on the screen.
- <Only for model with dual touch>
- The dual touch uses electromagnetic induction and may not work properly near strong electrical field or magnetic field such as:
 - Near AM radio base station or relay station antennas
 - Near CRT displays that generate strong electromagnetic field noiseMove the dual touch away from such locations so it will work properly.
 - The pointer cannot follow the digitizer pen movement if you move the digitizer pen too quickly.

■ When using peripheral devices

Follow these instructions and the Reference Manual to avoid any damage to the devices. Carefully read the instruction manuals of the peripheral devices.

- Use the peripheral devices conforming to the computer's specifications.
- Connect to the connectors in the correct direction.
- If it is hard to insert, do not try forcibly but check the connector's shape, direction, alignment of pins, etc.
- If screws are included, fasten them securely.
- Remove the cables when you carry the computer. Do not pull the cables forcibly.

■ Preventing your computer from unauthorized use via wireless LAN/Bluetooth/Wireless WAN

<Only for model with wireless LAN/Bluetooth/Wireless WAN>

- Before using wireless LAN/Bluetooth/Wireless WAN, make the appropriate security settings such as data encryption.

■ Battery Recalibration

- The battery recalibration may take a long time due to the large battery capacity. This is not a malfunction.

<When performing "Battery Recalibration" after shutting down Windows>

- Full charge: Approximately 3.5 hours
- Complete discharge: Approximately 4.0 hours

When performing "Battery Recalibration" without shutting down Windows, it may take more time to charge / discharge.

Maintenance

To clean the LCD panel

If drops of water or other stains get on the surface of the LCD panel, wipe them off immediately. Failure to do so may result in staining.

Use the soft cloth included with the computer. (For further information, refer to "Suggestions About Cleaning the LCD Surface" →  *Reference Manual* "Screen Input Operation".)

To clean areas other than the LCD panel

Wipe with a soft dry cloth such as gauze. When using detergent, dip a soft cloth in water-diluted detergent and wring it thoroughly.

CAUTION



- Do not use benzene, thinner, or rubbing alcohol since it may adversely affect the surface causing discoloration, etc. Do not use commercially-available household cleaners and cosmetics, as they may contain components harmful to the surface.
- Do not apply water or detergent directly to the computer, since liquid may enter inside of the computer and cause malfunction or damage.

Installing Software

Installing software will return the computer to the default condition. When you install the software, the hard disk data will be erased.

Back up important data to other media or an external hard disk before installation.

CAUTION

- Do not delete the Recovery Partition on the hard disk. The disk space in the partition is not available to store data. To check the Recovery Partition, perform the following methods.
 - ① **Windows 8.1**
Right-click  at the bottom left corner of the Desktop screen.
Windows 7
Click  (Start) and right-click [Computer], then click [Manage].
 - A standard user needs to enter an administrator password.
 - ② Click [Disk Management].

■ **Windows 8.1** Remove everything and reinstall Windows

Preparation

- Remove all peripherals.
- Connect the AC adaptor and do not remove it until installation is complete.

1 Perform “Remove everything and reinstall Windows”.

- ① Display “Charm” and click  - [Change PC settings] - [Update and recovery] - [Recovery].
- ② Click [Get Started] under “Remove everything and reinstall Windows”.
- ③ Click [Next].
- ④ Select the option.
 - Just remove my files
Perform the reinstallation of the Windows in a few moments (Approximately 20 minutes).
 - Fully clean the drive
By fully cleaning, the deleted files can not be recovered easily and the security level will be increased.
The processing time will be longer (Approximately 140 minutes).
Follow the on-screen instructions.
After the reinstallation, the computer will restart.
- Do not interrupt installation, for example by turning off the computer or performing other operation.
Otherwise installation may become unavailable as Windows may not start up or the data may be corrupted.



2 Perform the “First-time Operation” (→ page 9).

NOTE

- The date and time, and the time zone may not be correct. Be sure to set them correctly.

3 Perform Windows Update.

4 <Only for model with TPM> Clear TPM.

- ① Perform either of the following procedures.
 - Right-click  at the bottom left corner of the Desktop screen.
 - Click  on the Start screen.
- ② Click [Run], then input [tpm.msc] and click [OK].
- ③ Click [Clear TPM...] under “Actions” on the right of the “TPM Manager on Local Computer” screen.
- ④ Click [Restart] of the “Manage the TPM security hardware” screen.
The computer will restart.
- ⑤ When “TPM configuration change was requested to ...” is displayed, press **F12**.
- ⑥ Click the Desktop tile, and when “TPM is ready” appears, click [Close].

■ Hard disk recovery

You can reinstall the OS that was pre-installed at the time of purchase (Windows 8.1 or Windows 7).

Windows 8.1 If reinstallation using the method described in “Remove everything and reinstall Windows” is not successful, follow the steps below.

Preparation

- Remove all peripherals.
- Connect the AC adaptor and do not remove it until installation is complete.

1 Start the Setup Utility.

Windows 8.1

- ① Display “Charm”, and click  - [Change PC settings] - [Update and recovery] - [Recovery].
- ② Click [Restart now] under “Advanced startup”.
- ③ Click [Troubleshoot] - [Advanced options] - [UEFI Firmware Settings] - [Restart].

Windows 7

Turn on the computer, and press **F2** or **Del** while [Panasonic] boot screen is displayed.

- If the [Panasonic] boot screen is not displayed, turn on the computer while holding down **F2** or **Del**.
- If the password is requested, enter the Supervisor Password.

2 Write down all of the contents of the Setup Utility and press **F9**.

At the confirmation message, select [Yes] and press **Enter**.

3 Check the [UEFI Boot] setting of the Setup Utility.

[UEFI Boot] should be set to as follows.

When installing Windows 8.1 : [Enabled]

When installing Windows 7 : [Disabled]

4 Press **F10**.

At the confirmation message, select [Yes] and press **Enter**.

Computer will restart.

5 Press **F2** or **Del** while [Panasonic] boot screen is displayed.

The Setup Utility starts up.

- If the password is requested, enter the Supervisor Password.

6 Select the [Exit] menu, then select [Recovery Partition] and press **Enter**.

Windows 8.1

Click [Next] and click [YES].

Windows 7

Click [Reinstall Windows] and click [Next].

8 At the License Agreement screen, click [Yes, I agree to the provisions above and wish to continue!] and click [Next].

9 Click [Next].

If the option is displayed, select the setting and click [Next].

- [Reinstall Windows to the whole Disk to factory default.]
Select this option when you want to install Windows to the factory default. After installation, you can create a new partition. For how to create a new partition, refer to “To change the partition structure” (→ page 10).
 - [Reinstall to the OS related partitions.]¹⁾
Select this option when the hard disk has already been divided into several partitions and you want to keep the partition structure. For how to create a new partition, refer to “To change the partition structure” (→ page 10).
- ¹⁾ This does not appear if Windows cannot be installed to the recovery partition and the area usable by Windows.

10 **Windows 7** At the confirmation message, click [YES].

11 **Windows 7** Select OS (32bit or 64bit) and click [OK].

12 At the confirmation message, click [YES].

Installation starts according to the instructions on the screen. (It will take approximately 20 minutes.)

- Do not interrupt installation, for example by turning off the computer or performing other operation.
Otherwise installation may become unavailable as Windows may not start up or the data may be corrupted.

13 When Ending process screen is displayed, click [OK] to turn off the computer.

14 Turn on the computer.

- If the password is requested, enter the Supervisor Password.

Installing Software

15 Perform the “First-time Operation” (→ page 9).

NOTE

- **Windows 8.1** The date and time, and the time zone may not be correct. Be sure to set them correctly.

16 Start the Setup Utility and change the settings as necessary.

17 Perform Windows Update.

18 **Windows 8.1** <Only for model with TPM> Clear TPM (→ page 14).

■ Using Recovery Disc

Use the Recovery Disc in the following conditions.

- You have forgotten the administrator password.
- Installation is not complete. The recovery partition in the hard disk may be broken.
- **Windows 7** <Only for Windows 7 downgrade model>
To change OS from Windows 7 to Windows 8.1, or vice versa.

NOTE

- **Windows 7** To change OS from 32 bit to 64 bit, or vice versa, install OS using the recovery partition in the hard disk.

Preparation

- Prepare the following items:
 - Recovery Disc (→  *Reference Manual* “Recovery Disc Creation Utility”)
 - USB DVD drive (optional) (refer to recent catalogs and other sources for information about the products available)
- Remove all peripherals (except for the USB DVD drive).
- Connect the AC adaptor and do not remove it until installation is complete.

1 Connect the DVD drive to the USB port.

2 Start the Setup Utility.

Windows 8.1

- ① Display “Charm”, and click  - [Change PC settings] - [Update and recovery] - [Recovery].
- ② Click [Restart now] under “Advanced startup”.
- ③ Click [Troubleshoot] - [Advanced options] - [UEFI Firmware Settings] - [Restart].

Windows 7

Turn on the computer, and press **F2** or **Del** while [Panasonic] boot screen is displayed.

- If the [Panasonic] boot screen is not displayed, turn on the computer while holding down **F2** or **Del**.
- If the password is requested, enter the Supervisor Password.

3 Write down all of the contents of the Setup Utility and press **F9**.

At the confirmation message, select [Yes] and press **Enter**.

4 Check the [UEFI Boot] setting of the Setup Utility.

[UEFI Boot] should be set to as follows.

When the recovery disc for Windows 8.1 is used : [Enabled]

When the recovery disc for Windows 7 is used : [Disabled]

5 Set the Recovery Disc into the DVD drive.

6 Press **F10**.

At the confirmation message, select [Yes] and press **Enter**.
Computer will restart.

7 Press **F2** or **Del** while [Panasonic] boot screen is displayed.

The Setup Utility starts up.

- If the password is requested, enter the Supervisor Password.

8 Select the [Exit] menu, then select your DVD drive in [Boot Override] and press **Enter**.

The computer will restart.

9 Click [Reinstall Windows] and click [Next].

10 **Windows 8.1** At the confirmation message, click [YES].

11 At the License Agreement screen, click [Yes, I agree to the provisions above and wish to continue!] and click [Next].

12 Click [Next].

If the option is displayed, select the setting and click [Next].

- [Reinstall Windows to the whole Disk to factory default.]

Select this option when you want to install Windows to the factory default. After installation, you can create a new partition. For how to create a new partition, refer to “To change the partition structure” (→ page 10)

- [Reinstall to the OS related partitions.]²

Select this option when the hard disk has already been divided into several partitions and you want to keep the partition structure. For how to create a new partition, refer to “To change the partition structure” (→ page 10).

² This does not appear if Windows cannot be installed to the recovery partition and the area usable by Windows.

13 At the confirmation message, click [YES].

Installation starts according to the instructions on the screen. (It will take approximately 30 - 45 minutes.)

- Do not interrupt installation, for example by turning off the computer or pressing **Ctrl** + **Alt** + **Del**.

Otherwise installation may become unavailable as Windows may not start up or the data may be corrupted.

14 When Ending process screen is displayed, remove the Recovery Disc and DVD Drive and then click [OK].

Follow the on-screen instructions.

Some models may take approximately 40 minutes.

15 Perform the “First-time Operation” (→ page 9).

16 Start the Setup Utility and change the settings as necessary.

17 Perform Windows Update.

18 **Windows 8.1** <Only for model with TPM> Clear TPM (→ page 14).







Troubleshooting (Basic)

Follow the instructions below when a problem has occurred. There is also an advanced troubleshooting guide in the "Reference Manual". For a software problem, refer to the software's instruction manual. If the problem persists, contact Panasonic Technical Support (→ page 30). You can also check the computer's status in the PC Information Viewer (→  Reference Manual "Troubleshooting (Advanced)").

■ Starting Up





<p>Cannot start up. The power indicator or battery indicator is not lit.</p>	<ul style="list-style-type: none"> ● Connect the AC adaptor. ● Insert a fully charged battery. ● Remove the battery pack and the AC adaptor, then connect them again. ● If a device is connected to the USB port, disconnect the device, or set [USB Port] or [Legacy USB Support] to [Disabled] in the [Advanced] menu of the Setup Utility. ● If a device is connected to the ExpressCard slot, disconnect the device, or set [ExpressCard Slot] to [Disabled] in the [Advanced] menu of the Setup Utility. ● Press Fn + F8 to turn off the concealed mode. ● Check the [UEFI Boot] setting of the Setup Utility. [UEFI Boot] should be set to Windows 8.1 [Enabled] / Windows 7 [Disabled].
<p>The power is turned on but "Warming up the system" appears.</p>	<ul style="list-style-type: none"> ● The computer is warming up before start up. Wait for the computer to start up (the maximum waiting time will be displayed on the screen). If, "Cannot warm up the system" is displayed, the computer failed to warm up and does not start. In this case, turn off the computer, leave it in an environment of 5 °C {41 °F} or higher temperature for about an hour, and then turn on the power again.
<p>Cannot turn on the computer. The computer does not resume from sleep. (The power indicator blinks alternately in orange and green.)</p>	<ul style="list-style-type: none"> ● Leave it in an environment of 5 °C {41 °F} or higher temperature for about an hour, then turn on the power again.
<p>The computer does not enter sleep mode while the screen saver is running. (The screen stays black.)</p>	<ul style="list-style-type: none"> ● Slide and hold the power switch for 4 seconds or longer to shut down the computer forcibly. (Data not saved will be lost.) Then disable the screen saver.
<p>You have forgotten the password.</p>	<ul style="list-style-type: none"> ● Supervisor Password or User Password: Contact Panasonic Technical Support (→ page 30). ● Administrator password: <ul style="list-style-type: none"> • If you have a password reset disk, you can reset the administrator password. Set the disk and enter any wrong password, then follow the on-screen instructions and set a new password. • If you do not have a password reset disk, reinstall (→ page 14) and set up Windows, and then set a new password.
<p>"Remove disks or other media. Press any key to restart" or a similar message appears.</p>	<ul style="list-style-type: none"> ● A floppy disk is in the drive and it does not contain system startup information. Remove the floppy disk and press any key. ● If a device is connected to the USB port, disconnect the device, or set [USB Port] or [Legacy USB Support] to [Disabled] in the [Advanced] menu of the Setup Utility. ● If a device is connected to the ExpressCard slot, disconnect the device, or set [ExpressCard Slot] to [Disabled] in the [Advanced] menu of the Setup Utility. ● If the problem persists after removing the disk, it may be a hard disk failure. Contact Panasonic Technical Support (→ page 30). ● Set [UEFI Boot] to [Disabled] in the [Boot] menu of the Setup Utility.
<p>Windows startup and operation is slow.</p>	<ul style="list-style-type: none"> ● Press F9 in the Setup Utility (→  Reference Manual "Setup Utility") to return the Setup Utility settings (excluding the passwords) to the default values. Start the Setup Utility and make the settings again. (Note that the processing speed depends on the application software, so this procedure may not make Windows faster.) ● If you installed a resident software after purchase, turn off the residence. ● Disable the pop-up menu and Input Panel Tab. <ol style="list-style-type: none"> ① Open the Input Panel, and click [Tools] - [Options] - [Opening]. ② Remove the check mark of [Show Input Panel sliding open from the tab] and click [OK].

■ Starting Up



<p>The date and time are incorrect.</p>	<ul style="list-style-type: none"> ● Make the correct settings. <ol style="list-style-type: none"> ① Open the Control Panel. <ul style="list-style-type: none"> Windows 8.1 1. Perform either of the following procedures. <ul style="list-style-type: none"> • Right-click  at the bottom left corner of the Desktop screen. • Click  on the Start screen. 2. Click [Control Panel]. Windows 7 Click  (Start) - [Control Panel]. ② Click [Clock, Language, and Region] - [Date and Time]. <ul style="list-style-type: none"> ● If the problem persists, the internal clock battery may need to be replaced. Contact Panasonic Technical Support (→ page 30). ● When the computer is connected to LAN, check the date and time of the server. ● The 2100 A.D. or later year will not be correctly recognized on this computer.
<p>[Executing Battery Recalibration] screen appears.</p>	<ul style="list-style-type: none"> ● The Battery Recalibration was canceled before Windows was shut down last time. To start up Windows, turn off the computer by the power switch, and then turn on.
<p>[Enter Password] does not appear when resuming from sleep/hibernation.</p>	<ul style="list-style-type: none"> ● Select [Enabled] in [Password On Resume] in the [Security] menu of the Setup Utility (→  <i>Reference Manual</i> "Setup Utility"). ● The Windows password can be used instead of the password set in the Setup Utility. <ol style="list-style-type: none"> ① Add a password. <ul style="list-style-type: none"> Windows 8.1 1. Display "Charm" and click  - [Change PC settings] - [Accounts]. 2. Click [Sign-in options], and click [Add] under "Password". Windows 7 1. Click  (Start) - [Control Panel]. 2. Click [User Accounts and Family Safety] - [Add or remove user accounts]. ② Set up the following. <ul style="list-style-type: none"> Windows 8.1 1. Open the Control Panel, click [System and Security] - [Power Options] - [Require a password on wakeup]. 2. Add a check mark for [Require a password]. Windows 7 1. Click [Control Panel] - [System and Security] - [Power Option] - [Require a password when the computer wakes] and add a check mark for [Require a password].
<p>Cannot resume.</p>	<ul style="list-style-type: none"> ● One of the following operations may have been carried out. Slide the power switch to turn on the computer. Data not saved will be lost. <ul style="list-style-type: none"> • In sleep mode, the AC adaptor or battery pack was disconnected, or a peripheral was connected or disconnected. • The power switch was slid for four seconds or longer to forcibly turn off the computer. ● An error may occur when the computer automatically enters the sleep or hibernation mode while the screensaver is active. In this case, turn off the screensaver or change the pattern of the screensaver.

Troubleshooting (Basic)

■ Starting Up

<p>Other startup problems.</p>	<ul style="list-style-type: none"> ● Press F9 in the Setup Utility (→  Reference Manual “Setup Utility”) to return the Setup Utility settings (excluding the passwords) to the default values. Start the Setup Utility and make the settings again. ● Remove all peripheral devices. ● Check to see if there was a disk error. <ol style="list-style-type: none"> ① Remove all peripheral devices including an external display. ② Windows 8.1 Perform either of the following procedures. <ul style="list-style-type: none"> • Right-click  at the bottom left corner of the Desktop screen. • Click  on the Start screen. ③ Windows 7 Click  (Start) - [Computer]. ④ Click [File Explorer]. ⑤ Right-click Windows 8.1 [Windows (C:)] / Windows 7 [Local Disk (C:)], and click [Properties]. ⑥ Click [Tools] - Windows 8.1 [Check] / Windows 7 [Check Now...]. <ul style="list-style-type: none"> • A standard user needs to enter an administrator password. ⑦ Follow the on-screen instructions. ● Windows 7 Start the computer in Safe Mode and check the error details. When the [Panasonic] boot screen disappears^{*1} at startup, press and hold F8 until the Windows Advanced Options Menu is displayed. Select the Safe Mode and press Enter. <p>^{*1} When [Password on boot] is set to [Enabled] in the [Security] menu of the Setup Utility, [Enter Password] appears after the [Panasonic] boot screen disappears. As soon as you enter the password and press Enter, press and hold F8.</p>
--------------------------------	---



■ Entering Password

<p>Even after entering the password, password input screen is displayed again.</p>	<ul style="list-style-type: none"> ● The computer may be in ten-key mode. If the NumLk indicator  lights, press NumLk to disable the ten-key mode, and then input. ● The computer may be in Caps Lock mode. If the Caps Lock indicator  lights, press Caps Lock to disable the Caps Lock mode, and then input.
<p>Cannot log on to Windows. (“The user name or password is incorrect.” is displayed.)</p>	<ul style="list-style-type: none"> ● The user name (account name) includes an “@” mark. <ul style="list-style-type: none"> - If another user account name exists: Log on to Windows using another user account name, and delete the account name that includes “@”. Then create a new account name. - If no other account name exists: You need to reinstall Windows (→ page 14).

■ Shutting down

<p>Windows does not shut down.</p>	<ul style="list-style-type: none"> ● Remove the USB device and the ExpressCard. ● Wait one or two minutes. It is not a malfunction.
------------------------------------	---

■ Display

<p>No display.</p>	<ul style="list-style-type: none"> ● The external display is selected. Press Fn + F3 or Win + P to switch the display. Windows 7 Wait until the display has been switched completely before pressing Fn + F3 or Win + P again. Windows 8.1 Then click the display mode. ● When using an external display, <ul style="list-style-type: none"> • Check the cable connection. • Turn on the display. • Check the settings of external display. ● The display is turned off by the power-saving function. The screen returns to the original state when you operate keyboard or screen. When operating the keyboard, press a key that does not affect the computer operation, such as Ctrl. ● The computer entered sleep or hibernation by the power-saving function. To resume, slide the power switch.
<p>The screen is dark.</p>	<ul style="list-style-type: none"> ● The screen is darker when the AC adaptor is not connected. Press Fn + F2 and adjust the brightness. As you increase the brightness, battery consumption increases. You can separately set the brightness for when the AC adaptor is connected and when not connected. ● Press Fn + F8 to turn off the concealed mode.
<p>The screen is disordered.</p>	<ul style="list-style-type: none"> ● Changing the number of display colors and resolution may affect the screen. Restart the computer. ● Connecting/disconnecting an external display may affect the screen. Restart the computer. ● Resuming from sleep or hibernation may affect the screen of the external display. Restart the computer.
<p>During Simultaneous display, one of the screens becomes disordered.</p>	<ul style="list-style-type: none"> ● When using the Extended Desktop, use the same display colors for the external display as those used by the LCD. If you continue to experience problems, try changing the display. Right-click on the desktop, and click [Graphics Properties...] - [Display]. ● If you continue to experience problems, try changing the display. ● Simultaneous display cannot be used until Windows startup is complete (during Setup Utility, etc.).
<p>The external display does not work normally.</p>	<ul style="list-style-type: none"> ● If the external display does not support the power saving function, it may not work normally when the computer enters the power saving mode. Turn off the external display.
<p><Only for model with GPS> The pointer cannot be controlled properly.</p>	<ul style="list-style-type: none"> ● Operate the following steps. <ol style="list-style-type: none"> ① Set [GPS] to [Disabled] in the [Advanced] - [Serial Port Settings] of the Setup Utility. ② Press F10 and select [Yes] at the confirmation message, and press Enter. The computer will restart. ③ Log on to Windows as an administrator. ④ Windows 8.1 <ol style="list-style-type: none"> 1. Perform either of the following procedures. <ul style="list-style-type: none"> • Right-click  at the bottom left corner of the Desktop screen. • Click  on the Start screen. 2. Click [Run], input "c:\util\drivers\gps\GPS.reg" then click [OK]. Windows 7 Click  (Start) and input "c:\util\drivers\gps\GPS.reg" in [Search programs and files], and press Enter. ⑤ Click [Yes], click [Yes] and click [OK]. Then restart the computer. ⑥ Press F2 while [Panasonic] boot screen is displayed. ⑦ Set [GPS] to [Enabled] in the [Advanced] - [Serial Port Settings]. ⑧ Press F10 and select [Yes] at the confirmation message, and press Enter.

Troubleshooting (Basic)

■ Touch Pad / Touchscreen (only for model with touchscreen)/Dual Touch (only for model with dual touch)

The pointer does not work.	<ul style="list-style-type: none"> ● When using the external mouse, connect it correctly. ● Restart the computer using the keyboard. ● If the computer does not respond to keyboard commands, read “No response” (→ below).
Cannot input using the touch pad.	<ul style="list-style-type: none"> ● Set [Touch Pad] to [Enabled] in the [Main] menu of the Setup Utility. ● The drivers for some mice may disable the touch pad. Check your mouse’s operating instructions.
<Only for model with touchscreen> Cannot input using the touchscreen.	<ul style="list-style-type: none"> ● Set [Touchscreen Mode] to [Auto] or [Tablet Mode] in the [Main] menu of the Setup Utility. ● Set [Touchscreen] to [Enabled] in the [Advanced] menu of the Setup Utility.
Cannot point the correct position using the included stylus/digitizer pen.	<p><Only for model with touchscreen></p> <ul style="list-style-type: none"> ● Perform the touchscreen calibration (→ Reference Manual “Screen Input Operation”). ● Use the included stylus. <p><Only for model with dual touch></p> <ul style="list-style-type: none"> ● Perform the digitizer calibration and Touchscreen calibration (→ Reference Manual “Screen Input Operation”). Use the digitizer pen perpendicularly to the screen. ● Use the included digitizer pen. ● On the Windows logon screen or the Welcome screen, you may not be able to point the correct position using the included digitizer pen. Use the keyboard or the touch pad to Windows 8.1 sign in / Windows 7 log on.
Windows 8.1 “Charm” does not always appear by finger operation.	<ul style="list-style-type: none"> ● Flick toward the center of the screen from the right edge or press and hold (Enter) button. ● Use the included pen.

■ On-screen Document

Windows 7 The document of PDF format is not displayed.	<ul style="list-style-type: none"> ● Install Adobe Reader. <ol style="list-style-type: none"> ① Log on to Windows as an administrator. ② Click (Start) and input “c:\util\reader\en\Pinstall.bat” in [Search programs and files] then press Enter. ③ Update Adobe Reader to its latest version. If your computer is connected to the internet, start up Adobe Reader and click [Help] - [Check for Updates...].
--	--

■ Others

No response.	<ul style="list-style-type: none"> ● Press Ctrl + Shift + Esc to open Task Manager and close the software application that is not responding. ● An input screen (e.g., password input screen at startup) may be hidden behind another window. Press Alt + Tab to check. ● Slide the power switch for four seconds or longer to shut down the computer, and then slide the power switch to turn it on. If the application program does not work normally, uninstall and reinstall the program. To uninstall, <ol style="list-style-type: none"> ① Open the Control Panel. <ul style="list-style-type: none"> Windows 8.1 <ol style="list-style-type: none"> 1. Perform either of the following procedures. <ul style="list-style-type: none"> • Right-click at the bottom left corner of the Desktop screen. • Click on the Start screen. 2. Click [Control Panel]. Windows 7 <ul style="list-style-type: none"> Click (Start) - [Control Panel]. ② Click [Program] - [Uninstall a program].
--------------	---

LIMITED USE LICENSE AGREEMENT

THE SOFTWARE PROGRAM(S) (“PROGRAMS”) FURNISHED WITH THIS PANASONIC PRODUCT (“PRODUCT”) ARE LICENSED ONLY TO THE END-USER (“YOU”), AND MAY BE USED BY YOU ONLY IN ACCORDANCE WITH THE LICENSE TERMS DESCRIBED BELOW. YOUR USE OF THE PROGRAMS SHALL BE CONCLUSIVELY DEEMED TO CONSTITUTE YOUR ACCEPTANCE OF THE TERMS OF THIS LICENSE.

Panasonic Corporation has developed or otherwise obtained the Programs and hereby licenses their use to you. You assume sole responsibility for the selection of the Product (including the associated Programs) to achieve your intended results, and for the installation, use and results obtained therefrom.

LICENSE

- A. Panasonic Corporation hereby grants you a personal, non-transferable and non-exclusive right and license to use the Programs in accordance with the terms and conditions stated in this Agreement. You acknowledge that you are receiving only a LIMITED LICENSE TO USE the Programs and related documentation and that you shall obtain no title, ownership nor any other rights in or to the Programs and related documentation nor in or to the algorithms, concepts, designs and ideas represented by or incorporated in the Programs and related documentation, all of which title, ownership and rights shall remain with Panasonic Corporation or its suppliers.
- B. You may use the Programs only on the single Product which was accompanied by the Programs.
- C. You and your employees and agents are required to protect the confidentiality of the Programs. You may not distribute or otherwise make the Programs or related documentation available to any third party, by time-sharing or otherwise, without the prior written consent of Panasonic Corporation.
- D. You may not copy or reproduce, or permit to be copied or reproduced, the Programs or related documentation for any purpose, except that you may make one (1) copy of the Programs for backup purposes only in support of your use of the Programs on the single Product which was accompanied by the Programs. You shall not modify, or attempt to modify, the Programs.
- E. You may transfer the Programs and license them to another party only in connection with your transfer of the single Product which was accompanied by the Programs to such other party. At the time of such a transfer, you must also transfer all copies, whether in printed or machine readable form, of every Program, and the related documentation, to the same party or destroy any such copies not so transferred.
- F. You may not remove any copyright, trademark or other notice or product identification from the Programs and you must reproduce and include any such notice or product identification on any copy of any Program.

YOU MAY NOT REVERSE ASSEMBLE, REVERSE COMPILE, OR MECHANICALLY OR ELECTRONICALLY TRACE THE PROGRAMS, OR ANY COPY THEREOF, IN WHOLE OR IN PART.

YOU MAY NOT USE, COPY, MODIFY, ALTER, OR TRANSFER THE PROGRAMS OR ANY COPY THEREOF, IN WHOLE OR IN PART, EXCEPT AS EXPRESSLY PROVIDED IN THE LICENSE.

IF YOU TRANSFER POSSESSION OF ANY COPY OF ANY PROGRAM TO ANOTHER PARTY, EXCEPT AS PERMITTED IN PARAGRAPH E ABOVE, YOUR LICENSE IS AUTOMATICALLY TERMINATED.

TERM

This license is effective only for so long as you own or lease the Product, unless earlier terminated. You may terminate this license at any time by destroying, at your expense, the Programs and related documentation together with all copies thereof in any form. This license will also terminate effective immediately upon occurrence of the conditions thereof set forth elsewhere in this Agreement, or if you fail to comply with any term or condition contained herein. Upon any such termination, you agree to destroy, at your expense, the Programs and related documentation together with all copies thereof in any form.

YOU ACKNOWLEDGE THAT YOU HAVE READ THIS AGREEMENT, UNDERSTAND IT AND AGREE TO BE BOUND BY ITS TERMS AND CONDITIONS. YOU FURTHER AGREE THAT IT IS THE COMPLETE AND EXCLUSIVE STATEMENT OF THE AGREEMENT BETWEEN US, WHICH SUPERSEDES ANY PROPOSAL OR PRIOR AGREEMENT, ORAL OR WRITTEN, AND ANY OTHER COMMUNICATIONS BETWEEN US, RELATING TO THE SUBJECT MATTER OF THIS AGREEMENT.

GOVERNMENT RESTRICTED RIGHTS.

The Software is provided with “RESTRICTED RIGHTS.” Use duplication or disclosure by the government is subject to restrictions as set forth in FAR52.227-14 and DFAR252. 227-7013 et seq. or their successors.

Use of the Software by the government constitutes acknowledgement of Intel’s proprietary rights therein.

Contractor or Manufacturer is Intel Corporation, 2200 Mission College Blvd., Santa Clara, CA 95052.

Contrat de licence d'usage limité

Le(s) logiciel(s) (les "Logiciels") fournis avec ce produit Panasonic (le "Produit") sont exclusivement concédés en licence à l'utilisateur ultime ("vous"), et ils ne peuvent être utilisés que conformément aux clauses contractuelles ci-dessous. En utilisant les logiciels, vous vous engagez de manière définitive à respecter les termes, clauses et conditions des présentes.

Panasonic Corporation a mis au point ou obtenu les Logiciels et vous en concède l'utilisation par les présentes. Vous assumez l'entière responsabilité du choix de ce Produit (y compris des Logiciels associés) pour obtenir les résultats escomptés, ainsi que de l'installation, de l'utilisation et des résultats obtenus.

Licence

- A. Panasonic Corporation vous octroie par les présentes le droit et la licence personnels, non cessibles et non exclusifs d'utiliser les Logiciels conformément aux termes, clauses et conditions de ce contrat. Vous reconnaissez ne recevoir qu'un droit limité d'utiliser les Logiciels et la documentation les accompagnant et vous vous engagez à n'obtenir aucun droit de titre, propriété ni aucun autre droit vis-à-vis des Logiciels et de la documentation les accompagnant ni vis-à-vis des algorithmes, concepts, dessins, configurations et idées représentés par ou incorporés dans les Logiciels et la documentation les accompagnant, dont les titres, propriété et droits resteront tous à Panasonic Corporation ou à leurs propriétaires.
- B. Vous ne pouvez utiliser les Logiciels que sur le Produit unique qui est accompagné par les Logiciels.
- C. Vous et vos employés ou agents êtes requis de protéger la confidentialité des Logiciels. Vous ne pouvez ni distribuer ni mettre les Logiciels et la documentation les accompagnant à la disposition d'un tiers, par partage de temps ou de quelque autre manière que ce soit, sans l'autorisation écrite préalable de Panasonic Corporation.
- D. Vous ne pouvez ni copier ni reproduire ni permettre la copie ni la reproduction des Logiciels ni de la documentation les accompagnant pour quelque fin que ce soit, à l'exception d'une (1) copie des Logiciels à des fins de sauvegarde uniquement pour soutenir votre utilisation des Logiciels sur le Produit unique qui est accompagné par les Logiciels. Vous ne pouvez ni modifier ni tenter de modifier les Logiciels.
- E. Vous ne pouvez céder les Logiciels et en octroyer la licence à une autre partie qu'en rapport avec votre cession du Produit unique qui est accompagné par les Logiciels à cette autre partie. Au moment de cette cession, vous devez céder également toutes les copies, que ce soit sous forme imprimée ou lisible par la machine, de tous les Logiciels ainsi que de la documentation les accompagnant, à la même partie ou détruire les copies non cédées.
- F. Vous ne pouvez retirer aucune marque de droits d'auteur, marque de commerce ou autre ni aucune identification de produit des Logiciels et vous devez reproduire et inclure toutes ces notices ou identifications de produit sur toutes les copies des Logiciels.

Vous ne pouvez assembler en sens inverse, compiler en sens inverse ni retracer les Logiciels ni aucune de leurs copies, de façon électronique ou mécanique, en tout ou en partie.

Vous ne pouvez utiliser, copier, modifier, altérer ni céder les Logiciels ni aucune de leurs copies, en tout ou en partie, à l'exception de ce qui est expressément stipulé dans ce contrat.

Si vous cédez la possession de toute copie ou de tout Logiciel à une autre partie, à l'exception de ce qui est autorisé au paragraphe E ci-dessus, votre licence est automatiquement résiliée.

Termes, clauses et conditions

Cette licence n'est effective que pour la durée de possession ou de crédit-bail du Produit, à moins d'une résiliation antérieure. Vous pouvez résilier cette licence à tout moment en détruisant, à vos frais, les Logiciels et la documentation les accompagnant avec toutes leurs copies, sous quelque forme que ce soit. Cette licence sera également résiliée, avec application immédiate, si les conditions de résiliation définies ailleurs dans ce contrat se sont réalisées ou si vous ne respectez pas les termes, clauses et conditions qui y sont contenues. Au moment de la résiliation, vous acceptez de détruire, à vos frais, les Logiciels et la documentation les accompagnant avec toutes leurs copies, sous quelque forme que ce soit.

Vous reconnaissez avoir lu ce contrat, en avoir compris toute la substance et avoir accepté de respecter ses termes, clauses et conditions. Vous reconnaissez en outre qu'ils sont la description complète et exclusive du contrat conclu entre nous, contrat qui remplace et annule toute proposition ou contrat précédent, écrit ou oral, et toute autre communication entre nous, relativement à l'objet du présent contrat.

Specifications

This page provides the specifications for the basic model.
The model number is different according to the unit configuration.

- To check the model number:
Check the bottom of the computer or the box the computer came in at the time of purchase.
- To check CPU speed, memory size and the hard disk drive (HDD) size:
Run the Setup Utility (→  *Reference Manual* "Setup Utility") and select [Information] menu.
[Processor Speed]: CPU speed, [Memory Size]: Memory size, [Hard Disk]: Hard disk drive size

■ Main Specifications

CPU/Secondary cache memory	Intel® Core™ i5-3610ME Processor (3 MB ^{*1} cache, up to 3.3 GHz) with Intel® Turbo Boost Technology	
Chip Set	Mobile Intel® 7 QM77 Express Chipset	
Video controller	Intel® HD Graphics 4000 (Built-in CPU)	
Main Memory ^{*2}	4 GB ^{*1} , DDR3L SDRAM (8 GB ^{*1} Max.)	
Storage	Hard Disk Drive : 500 GB ^{*3} / Flash Memory Drive : 128 GB ^{*3} / 256 GB ^{*3} Windows 8.1 Approx. 13 GB ^{*3} is used as a partition with HDD recovery tools. (Users cannot use this partition.) Approx. 1 GB ^{*3} is used as a partition with system tools. (Users cannot use this partition.) Windows 7 Approx. 40 GB ^{*3} is used as a partition with HDD recovery tools. (Users cannot use this partition.) Approx. 300 MB ^{*3} is used as a partition with system tools. (Users cannot use this partition.)	
Display Method	10.1 XGA type (TFT) (1024 × 768 dots)	
Internal LCD	65,536 / 16,777,216 colors (800 × 600 dots / 1024 × 768 dots) ^{*4}	
External Display ^{*5}	65,536 / 16,777,216 colors (800 × 600 dots / 1024 × 768 dots / 1280 × 768 dots / 1280 × 1024 dots)	
Wireless LAN ^{*6}	Intel® Centrino® Advanced-N 6235 (a/b/g/n) → page 26	
Bluetooth ^{*7}	→ page 27	
Wireless WAN ^{*8}	Sierra Wireless™ High-speed module	
GPS ^{*9}	Chip: u-blox M8 Accuracy: 10 m (2DRMS), 5 m (2DRMS, SBAS)	
LAN	IEEE 802.3 10Base-T / IEEE 802.3u 100BASE-TX / IEEE 802.3ab 1000BASE-T	
Modem ^{*10}	Data: 56 kbps (V.92) FAX: 14.4 kbps	
Sound	WAVE and MIDI playback, Intel® High Definition Audio subsystem support	
Security Chip	TPM (TCG V1.2 compliant) ^{*11}	
Card Slot	PC Card Slot	x 1, Type I or Type II, Allowable current 3.3 V: 400 mA, 5 V: 400 mA
	ExpressCard Slot ^{*12}	x 1, ExpressCard/34 or ExpressCard/54
	SD Memory Card Slot ^{*13}	x 1
	Contact Smart Card Slot ^{*14}	x 1
RAM Module Slot	DDR3L SDRAM, 204-pin, 1.35 V, SO-DIMM, PC3L-10600 Compliant	
Interface	USB Ports x 2 (USB 2.0 x 1 + USB 3.0 x 1) ^{*15} / Serial Port (Dsub 9-pin male) / Modem Port (RJ-11) ^{*10} / LAN Port (RJ-45) / VGA Port (Mini Dsub 15-pin female) / IEEE1394a Interface Connector (4-pin) ^{*16} / Microphone Jack (Miniature jack, 3.5 DIA) / Headphone Jack (Miniature jack, 3.5 DIA, Impedance 32 Ω, Output Power 4 mW × 2, Stereo) / Expansion Bus Connector (Dedicated 100-pin female), External Antenna Connector (Dedicated 50 W coaxial connector) x 2	
Keyboard / Pointing Device	82 keys / Touch Pad / Touchscreen (Anti-Reflection, Stylus (included) touch capable) ^{*17}	82 keys / Touch Pad / Dual Touch (Anti-Reflection, Digitizer pen (included) touch capable) ^{*17}
Fingerprint Reader ^{*18}	Image Size : 200 x 400 pixels , Image Resolution : 508 DPI	
Camera ^{*19}	1280 x 720 dots, 30 fps (Video) 2048 x 1536 dots (still)	
Power Supply	AC adaptor or Battery pack	
AC Adaptor ^{*20}	Input: 100 V - 240 V AC, 50 Hz/60 Hz, Output: 15.6 V DC, 7.05 A	

Specifications

■ Main Specifications

Battery Pack		Li-ion 10.65 V, Typical 5700 mAh / Minimum 5400 mAh	
Operating Time ^{*21}		Approx. 10 hours	Approx. 9.5 hours
Charging Time ^{*22}		Approx. 3.5 hours	
Power Consumption ^{*23}		Approx. 30 W ^{*24} / Approx. 90 W (maximum when recharging in the ON state)	
Physical Dimensions (W × D × H) (including the carrying handle)		271 mm × 216 mm × 49 mm {10.7" × 8.5" × 1.93 "}	
Weight (including the hand strap)		Approx. 2.30 kg {Approx. 5.06 lb.}	
Environment	Operating	Temperature	-10 °C to 50 °C {14 °F to 122 °F} (IEC60068-2-1, 2) ^{*25}
		Humidity	30 % to 80 % RH (No condensation)
	Storage	Temperature	- 20 °C to 60 °C {-4 °F to 140 °F}
		Humidity	30 % to 90 % RH (No condensation)

■ Software

Base OS	Windows® 8.1 Update Pro 64-bit
Installed OS ^{*26}	<p>Windows 8.1 Windows® 8.1 Update Pro 64-bit</p> <p>Windows 7 Windows® 7 Professional 32-bit Service Pack 1 (downgraded to Windows® 7)^{*27} / Windows® 7 Professional 64-bit Service Pack 1 (downgraded to Windows® 7)^{*27}</p>
Pre-installed Software	<p>Adobe Reader, PC Information Viewer, Intel® PROSet/Wireless Software^{*6}, Intel® PROSet/Wireless Software for Bluetooth® Technology^{*7}, Hotkey Settings, Battery Recalibration Utility, Infineon TPM Professional Package^{*11 *28}, Aptio Setup Utility, PC-Diagnostic, Hard Disk Data Erase Utility^{*29}, Recovery Disc Creation Utility, Dashboard for Panasonic PC, Power Plan Extension Utility, Camera Utility^{*19}, Camera Light Switch Utility^{*19}, GPS Viewer^{*9}, Manual Selector, Microsoft Office Trial^{*30}, Display Rotation Tool, Wireless Manager Mobile Edition 6.0^{*28 *31}, DDS EVE FA Standalone for Panasonic^{*18 *28}</p> <p>Windows 8.1 Camera for Panasonic PC, Wireless Toolbox</p> <p>Windows 7 Wireless Switch Utility, Wireless Connection Disable Utility^{*6 *8 *28}, Quick Boot Manager, Tablet Buttons for Panasonic PC, Bluetooth Stack for Windows by Toshiba</p>

■ Wireless LAN

Data Transfer Rates	<p>IEEE802.11a : 54/48/36/24/18/12/9/6 Mbps (automatically switched)^{*32}</p> <p>IEEE802.11b : 11/5.5/2/1 Mbps (automatically switched)^{*32}</p> <p>IEEE802.11g : 54/48/36/24/18/12/9/6 Mbps (automatically switched)^{*32}</p> <p>IEEE802.11n^{*33} : (HT20) GI^{*34} = 400ns: 150/130/115/86/72/65/57/43/39/28/21/14/7 Mbps (automatically switched)^{*32}</p> <p style="padding-left: 100px;">GI^{*34} = 800ns: 130/117/104/78/65/58/52/39/26/19/13/6 Mbps (automatically switched)^{*32}</p> <p style="padding-left: 100px;">(HT40) GI^{*34} = 400ns: 300/270/240/180/150/135/120/90/60/45/30/15 Mbps (automatically switched)^{*32}</p> <p style="padding-left: 100px;">GI^{*34} = 800ns: 270/243/216/162/135/121/108/81/54/40/27/13 Mbps (automatically switched)^{*32}</p>
Standard Supported	IEEE802.11a / IEEE802.11b / IEEE802.11g / IEEE802.11n
Transmission Method	OFDM system, DS-SS system
Wireless Channels Used	<p>IEEE802.11a : Channels 36/40/44/48/52/56/60/64/100/104/108/112/116/120/124/128/132/136/140/149/153/157/161/165</p> <p>IEEE802.11b/IEEE802.11g : Channels 1 to 11</p> <p>IEEE802.11n : Channels 1-11/36/40/44/48/52/56/60/64/100/104/108/112/116/120/124/128/132/136/140/149/153/157/161/165</p>
RF Frequency Band	<p>IEEE802.11a : 5.18 GHz - 5.32 GHz, 5.5 GHz - 5.7 GHz, 5.745 GHz - 5.825 GHz</p> <p>IEEE802.11b/IEEE802.11g : 2.412 GHz - 2.462 GHz</p> <p>IEEE802.11n : 2.412 GHz - 2.462 GHz, 5.18 GHz - 5.32 GHz, 5.5 GHz - 5.7 GHz, 5.745 GHz - 5.825 GHz</p>

■ **Bluetooth®** *7

Bluetooth Version	Version 4.0
	Classic mode / Low Energy mode
Transmission method	FHSS system
Wireless Channels Used	Channels 1 to 79 / Channels 0 to 39
RF Frequency Band	2.402 GHz - 2.480 GHz

*1 1 MB = 1,048,576 bytes / 1 GB = 1,073,741,824 bytes

*2 Memory size of the factory default depends on the model. You can physically expand the memory up to 8 GB, but the total amount of usable memory available will be less depending on the actual system configuration.

*3 1 MB = 1,000,000 bytes / 1 GB = 1,000,000,000 bytes. Your operating system or some application software will report as fewer GB.

*4 A 16,777,216 color display is achieved by using the dithering function.

*5 Display may be impossible using some connected external displays.

*6 Only for model with wireless LAN.

*7 Does not guarantee operation of all Bluetooth peripherals.

*8 Only for model with wireless WAN. The specifications may differ depending on the model.

A SIM card (15 mm {0.59"} x 25 mm {0.98"}) must be inserted in the SIM card slot.

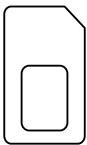

*9 Only for model with GPS.

*10 Only for model with modem.

*11 Only for model with TPM.

For information on TPM, refer to the Installation Manual of "Trusted Platform Module (TPM)" by the following procedure.

Windows 8.1

On the Start screen, click the [Manual Selector] tile, and select "Installation Manual for Trusted Platform Module (TPM)"

Windows 7

Double-click [Manual Selector] on the desktop, and select "Installation Manual for Trusted Platform Module (TPM)".

*12 Only for model with ExpressCard slot.

*13 This slot is compatible with High-Speed Mode. Operation has been tested and confirmed using Panasonic SD/SDHC/SDXC Memory Cards with a capacity of up to 64 GB. Operation on other SD equipment is not guaranteed.

*14 Only for model with Smart Card slot.

*15 Does not guarantee operation of all USB-compatible peripherals.

*16 Only for model with IEEE 1394a interface.

*17 Only for model with Touchscreen.

*18 Only for model with Fingerprint reader.

*19 Only for model with Camera. The specifications may differ depending on the model.

*20 <Only for North America>

The AC adaptor is compatible with power sources up to 240 V AC adaptor. This computer is supplied with a 125 V AC compatible AC cord. 20-M-2-1

*21 Measured with LCD brightness : 60 cd/m²

Varies depending on the usage conditions, or when an optional device is attached.

*22 Varies depending on the usage conditions, CPU speed, etc.

*23 Approx. 0.9 W when the battery pack is fully charged (or not being charged) and the computer is off.

<When using with 115 V AC>

Even when the AC adaptor is not connected to the computer, power is consumed (Max. 0.2 W) simply by having the AC adaptor plugged into an AC outlet.

*24 Rated power consumption. 23-E-1

*25 Do not expose the skin to this product when using the product in a hot or cold environment. (➔ OPERATING INSTRUCTIONS - Read Me First) When using in hot or cold environment, some peripherals may fail to work properly. Check the operation environment of the peripherals.

Using this product continuously in a hot environment will shorten the product life. Avoid use in these types of environments.

When using in low temperature environment, startup may become slow or battery operation time may become short.

The computer consumes power when the hard disk is warming up during startup. Therefore, if you are using battery power and the remaining power is low, the computer may not start up.

*26 Operations of this computer are not guaranteed except for the pre-installed OS and the OS which is installed by using the Recovery disc provided by Panasonic.

*27 This system is preinstalled with Windows® 7 Professional software and also comes with a license for Windows 8.1 Pro software. You may only use one version of the Windows software at a time. Switching between versions will require you to uninstall one version and install the other version.

*28 Must be installed before use.

*29 Perform on the recovery disc.

Windows 7



Alternatively perform on the hard disk recovery partition.

*30 To continue using this software after the end of the trial, purchase a license by following the on-screen instructions.

Specifications

^{*31} For information on Wireless Manager, refer to the “Supplementary Instructions for Wireless Manager mobile edition” by the following procedure.

Windows 8.1

- ① Perform either of the following procedures.
 - Right-click  at the bottom left corner of the Desktop screen.
 - Click  on the Start screen.
- ② Click [Run], input “c:\util\wlprjct\Supplementary Instructions.pdf” then click [OK].

Windows 7

- ① Click  (Start) and input “c:\util\wlprjct\Supplementary Instructions.pdf” in [Search programs and files] and press **Enter**.

^{*32} These are speeds specified in IEEE802.11a+b+g+n standards. Actual speeds may differ.

^{*33} Available when set to “WPA-PSK”, “WPA2-PSK” or “none”.

^{*34} Only available when HT40 enabled by the computer.

LIMITED WARRANTY

For U.S.A.

Panasonic System Communications Company of North America (PSCNA)
Computer Products - Worldwide Warranties

Section 1: Limited Warranty - Hardware

PSCNA, referred hereafter as "Panasonic" will repair the products listed below with new or rebuilt parts, free of charge in a Global Panasonic designated service location for the period specified below from the date of original purchase in the event of a defect in materials or workmanship. These warranties are extended solely to the original purchaser. A purchase receipt or other proof of date of original purchase will be required before warranty performance is rendered.

- Laptop PC (CF-##) – 3 Years
- Tablet PC (FZ-##) – 3 Years
- Ultra-Mobile (CF-U#/CF-H# Series) – 3 Years
- PDRC - LCD & Keyboard Assembly – 3 Years

Battery Warranty

Batteries supplied with the product are covered under the warranty for one (1) year from date of purchase, except as excluded in Section 3. Batteries purchased separately are covered under the warranty for one (1) year from the date of purchase. A replacement battery furnished under the product warranty is covered for the remaining period of the one year warranty on the original or purchased battery.

Optional: Panasonic "Protection Plus" Warranty

Any unit for which the Panasonic "Protection Plus" warranty has been purchased will receive additional coverage for any failure that occurs due to accidental damage. All other terms and conditions of the standard warranty apply and this additional coverage will exist for the duration of the standard warranty period of the unit. If an extended Protection Plus warranty program is purchased, coverage is extended to the end of the last year of extended coverage purchased.

This warranty does not cover failures or defects that are caused by fire, intentional acts, loss, theft, improper maintenance, modification or service by anyone other than the Panasonic National Service Center or a Panasonic Authorized Service Provider, or damage that is attributable to acts of God. Cosmetic damage that does not affect functionality is not covered. Cosmetic damage on units with hardware failures will be repaired in accordance with the warranty terms. This warranty is extended solely to the original purchaser on the unit serial number for which it was purchased. Complete unit replacement fulfills the full obligation and is at the discretion of Panasonic and is limited to once during the coverage term. Maximum benefit is limited to one replacement per coverage year of the Motherboard, LCD, Storage Drive, and Keyboard.

Wireless Module Warranty

Panasonic approved wireless modems installed in Panasonic brand computers and integrated by Panasonic or an Authorized Panasonic Wireless Integrator are covered under the warranty for the remaining warranty period of the device in which the modem is installed. For devices with less than three (3) months remaining on the unit warranty, the wireless modem will be covered for a period of three (3) months from the date of installation of the modem, covering only modem replacement or modem installation related issues.

All modems must be approved by the wireless carrier prior to use. Any use or attempted use of a wireless modem not approved and activated by the carrier for use on their network is strictly prohibited and is not sanctioned or warranted by Panasonic and may result in legal action. In addition, all modems must be approved by Panasonic as compatible with the device hardware before installation or use.

Panasonic's sole responsibility for the warranty or technical support of the software required to install or operate the modem is defined in Section 2 (Limited Software Warranty). Any attempted software installation by anyone other than a Panasonic Authorized Wireless Integrator is not covered under warranty and may result in service charges to re-image or replace the hard drive.

Installation or attempted installation by any party other than Panasonic or an Authorized Panasonic Wireless Integrator is strictly not covered under the warranty and may void the computer warranty if damage results.

Options and Accessories Warranties

The below listed Panasonic brand or supplied options and accessories are covered under this limited warranty for the period specified from the date of purchase or as specifically stated:

- AC Adaptor / Power Cord – 3 Years
- Memory Expansion Card (Panasonic Brand) – 3 Years
- Car Mount - Docking Station PCB or Vehicle Docking Station – 3 Years
- Desktop Port Replicator, I-O Box, Docking Cradle (like CF-U1) – 3 Years
- Antenna Pass-through Cable – 3 Years
- Backlit or Full-sized keyboard - 3 Years or assumes warranty of the unit in which it is installed
- Integrated Panasonic supplied options and kits including, but not limited to Wireless Modems, Media Bay Drives (Floppy, CD, DVD, Combo), Camera, GPS, Bluetooth, Smartcard Reader, Magnetic Card Reader, Barcode Scanner, and Fingerprint Reader - 3 Years or assumes warranty period of the unit in which it is installed provided the integration was performed by Panasonic or an Authorized Integrator.
- Hard Drive / Solid State Drive (Internal) - 3 Years
- Separately purchased 2nd Hard Drive – 1 Year
- External USB Drives (CD / DVD / Floppy / Hard Drive) – 1 Year
- Optional Battery – 1 Year
- Battery Charger / Multi-Bay Battery Charger – 1 Year
- Stylus Pens, Digitizer & Standard - 90 Days (physical damage excluded)

LIMITED WARRANTY

Section 2 - Limited Warranty - Software

Panasonic warrants to you only that the disk(s) or other media on which the Programs are furnished will be free from defects in material and workmanship under normal use for a period of sixty (60) days from the date of delivery thereof to you, as evidenced by your purchase receipt.

This is the only warranty Panasonic makes to you. Panasonic does not warrant that the functions contained in the Programs will meet your requirements or that the operation of the Programs will be uninterrupted or error free. Panasonic shall have no obligation for any defects in the disk(s) or other media on which the Programs are furnished resulting from your storage thereof, or for defects that have been caused by operation of the disk(s) or other media

Panasonic's entire liability and your exclusive remedy under this warranty shall be limited to the replacement, in the United States or other Panasonic designated location, of any defective disk or other media which is returned to Panasonic's Authorized Service Center, together with a copy of the purchase receipt, within the aforesaid warranty period.

Section 3 - Limited Warranty Exclusions - Specifically excluded from the warranty are:

- All consumable items; such as screen protection films, logo badges, labels, cleaning cloths, carry cases, manuals, cables, straps, belts, holsters, tethers, and harnesses and any other options and accessories not listed above or covered under a separate warranty.
- Failures related to the product operating system, hard drive or solid state drive image, software setup, software program, virus, other program(s) or file(s) on any drive or in any computer memory location.
- Failures due to BIOS settings or changes, as well as any cosmetic or physical damage to the unit.
- Any unit or device with a missing or altered model number or serial number label
- Cosmetic damage or any damage which occurs in shipment
- Failures which are caused by products not supplied by Panasonic
- Failures which result from alteration, accident, misuse, introduction of liquid or other foreign matter into the unit, abuse, neglect, installation, maladjustment of consumer controls, improper maintenance or modification, use not in accordance with product use instructions
- Failures due to service by anyone other than a Panasonic Authorized Service Provider
- Failures caused by improper installation of options or accessories or due to integration by any company other than Panasonic or a Panasonic Authorized Integrator
- Damage, failure, or loss due to the unit being stolen, lost, misplaced, or used by anyone other than the original purchaser
- Damage that is attributable to acts of God

This limited warranty only covers failures due to defects in materials or workmanship which occur during normal use. If a unit is sent to a Panasonic Authorized Service Center and no hardware failure is found, the customer will be billed for labor to correct a software issue or reimage the hard drive plus shipping and applicable administrative fees at the current rates set by the service provider.

THIS PRODUCT IS NOT INTENDED FOR USE AS OR PART OF NUCLEAR EQUIPMENT/SYSTEMS, AIR TRAFFIC CONTROL EQUIPMENT/SYSTEMS, OR AIRCRAFT COCKPIT EQUIPMENT/SYSTEMS^{*1}. PANASONIC WILL NOT BE RESPONSIBLE FOR ANY LIABILITY RESULTING FROM THE USE OF THIS PRODUCT ARISING OUT OF THE FOREGOING USES.

^{*1} AIRCRAFT COCKPIT EQUIPMENT/SYSTEMS include class 2 Electronic Flight Bag (EFB) Systems and Class 1 EFB Systems when used during critical phases of flight (e.g., during take-off and landing) and/or mounted onto the aircraft. Class 1 EFB Systems and 2 EFB Systems are defined by FAA: AC (Advisory Circular) 120-76A or JAA: JAA TGL (Temporary Guidance Leaflets) No. 36.

Other Limits and Exclusions: There are no other express warranties except as listed above.

PANASONIC SHALL NOT BE LIABLE FOR LOSS OF DATA OR OTHER INCIDENTAL OR CONSEQUENTIAL DAMAGES RESULTING FROM THE USE OF THIS PRODUCT, OR ARISING OUT OF ANY BREACH OF THIS WARRANTY. ALL EXPRESS AND IMPLIED WARRANTIES, INCLUDING THE WARRANTIES OF MERCHANTABILITY AND FITNESS FOR A PARTICULAR PURPOSE ARE LIMITED TO THE APPLICABLE WARRANTY PERIOD SET FORTH ABOVE. Some states do not allow the exclusion or limitation of incidental or consequential damages, or limitations on how long an implied warranty lasts, so the above limitations or exclusions may not apply to you.

This limited warranty gives you specific legal rights, and you may also have other rights which vary from state to state.

For technical support or to arrange for service on your Panasonic computer product, call our toll-free hotline at 1-855-PSC-TECH (855-772-8324).

DIAL TOLL FREE: 1-855-PSC-TECH (855-772-8324)
Web Site : www.panasonic.com/toughbook

For Canada

PANASONIC COMPUTER AND PERIPHERALS LIMITED WARRANTY

Coverage – Panasonic Canada Inc. (“PCI”) warrants to you, the first end user customer, this computer product (excluding software media), when purchased from PCI or from a PCI authorized reseller, to be free from defects in materials and workmanship under normal use, subject to the terms set forth below, during the period of warranty coverage specified.

Scope of Coverage	Period of Coverage	Type of Failure Coverage
<ul style="list-style-type: none"> Laptop Computers (except Battery) and AC Adaptor Factory/PCI installed options including Wireless WAN, GPS, Bluetooth, Finger print reader, Backlit keyboard, Memory Card and Media Bay Drives (Floppy, CD/DVD) Mobile Wireless Display PDRC – LCD and Keyboard Assemblies Port Replicator 	Three (3) Years from Date of Original End User Customer Purchase	Defective Materials or Workmanship
<ul style="list-style-type: none"> Hand-held Computers Battery Battery charger Auto Adaptor External USB Drives 	One (1) Year from Date of Original End User Customer Purchase	Defective Materials or Workmanship
<ul style="list-style-type: none"> Digitizer pen or stylus 	Ninety (90) Days from Date of Original End User Customer Purchase	Defective Materials or Workmanship
<ul style="list-style-type: none"> All consumable items including protection film, cleaning cloth, carry case, tether and harness 	No Coverage	

Remedy – In the event of a warranty claim, contact PCI’s representatives within the applicable warranty period, identifying the nature of the defect claimed, at 1-800-668-8386 between 9:00 A.M. and 5:00 P.M., Eastern Time Zone, Mon. – Fri. (excluding holidays) for instructions on how to obtain service. A purchase receipt or other proof of date of original purchase is required before warranty service is performed. Defective parts covered by this Limited Warranty will be repaired or replaced with new or comparable rebuilt parts on an exchange basis. Warranty replacement or repair is subject to the terms of this Limited Warranty for the balance of the original period of warranty coverage.

No Coverage – This Limited Warranty does not cover products purchased outside Canada. Neither does it cover damage to, failure of, or defects in a product or accessory through mishandling, improper installation, abnormal use, misuse, neglect, accident, introduction of liquid or other foreign matter into the product, alteration or servicing by anyone not authorized by PCI, or act of God. THIS PRODUCT IS NOT INTENDED FOR USE AS, OR AS PART OF, NUCLEAR EQUIPMENT/SYSTEMS, AIR TRAFFIC CONTROL EQUIPMENT/SYSTEMS, OR AIRCRAFT COCKPIT EQUIPMENT/SYSTEMS². PANASONIC WILL NOT BE RESPONSIBLE FOR ANY LIABILITY RESULTING FROM THE USE OF THIS PRODUCT ARISING OUT OF THE FOREGOING USES.

² AIRCRAFT COCKPIT EQUIPMENT/SYSTEMS include Class2 Electrical Flight Bag (EFB) Systems and Class1 EFB Systems when used during critical phases of flight (e.g., during take-off and landing) and/or mounted on to the aircraft. Class1 EFB Systems and 2 EFB Systems are defined by FAA: AC (Advisory Circular) 120-76A or JAA: JAA TGL (Temporary Guidance Leaflets) No.36

IF YOU SHIP THE PRODUCT FOR WARRANTY SERVICE

Carefully pack the product, preferably in the original carton. Include details of defect claimed and proof of date of original purchase. No liability is assumed for loss or damage to the product while in transit, if you chose your own transportation carrier.

SOFTWARE MEDIA LIMITED WARRANTY

Coverage – PCI warrants to you, the first end user customer, that the disk(s) or other media on which software program(s) is/are supplied will be free from defects in materials and workmanship under normal use in Canada for a period of sixty (60) days from date of receipt as evidenced by your purchase receipt for your Panasonic Computer product.

THIS IS THE ONLY WARRANTY THAT PCI MAKES RESPECTING THE SOFTWARE MEDIA. PCI does not warrant the software. Please refer to the software licensor’s written warranty (accompanying the copy of the software) for any software warranty claim.

Claim Procedure – In the event of a defect in material or workmanship in the media during the sixty (60) day warranty period, and you return it, transportation costs prepaid, to Panasonic Canada Inc., Computer Products Marketing, 5770 Ambler Drive, Mississauga, Ontario L4W 2T3, within the warranty period, together with a copy of your purchase receipt, and an explanation of the suspected defect, PCI will replace in Canada the defective disk(s) or other media.

Remedy – PCI’s entire liability, and your only remedy for any breach of this software media warranty is limited to replacement of the media only. It does not cover any other damages, including, but not limited to, loss of use or profit loss, or special, indirect or consequential damages, or other claims, whether or not of similar character.

No Coverage – This limited warranty does not apply if the disk(s) or other media has been used in other than a Panasonic product, or in environmental conditions other than those specified by PCI or the manufacturer, or if subjected to misuse, neglect, mishandling, modification or attempted modification of the program, or if damaged by accident or act of God. PCI is not responsible for damage to or loss of any program, data or removable storage media.

GENERAL

NO OTHER WARRANTIES – PCI DISCLAIMS ALL OTHER WARRANTIES, EITHER EXPRESS OR IMPLIED, INCLUDING, BUT NOT LIMITED TO, IMPLIED WARRANTIES OF MERCHANTABILITY AND FITNESS FOR A PARTICULAR PURPOSE, WITH RESPECT TO THE SOFTWARE, SOFTWARE MEDIA, COMPUTER PRODUCT, OPTIONS AND ACCESSORIES.

NO LIABILITY FOR CONSEQUENTIAL DAMAGES – IN NO EVENT SHALL PCI BE LIABLE FOR ANY SPECIAL, INDIRECT OR CONSEQUENTIAL DAMAGES ARISING FROM ANY BREACH OF THE LIMITED WARRANTIES SET OUT IN THIS DOCUMENT, OR FROM THE USE OF THE COMPUTER PRODUCT, INCLUDING, WITHOUT LIMITATION, LOSS OF DATA, BUSINESS, PROFIT OR GOODWILL.

IN ANY EVENT, PCI’S MAXIMUM LIABILITY FOR ANY BREACH SHALL NOT EXCEED THE AMOUNT ACTUALLY PAID BY YOU FOR THE COMPUTER PRODUCT.

NO ACTION, REGARDLESS OF ITS BASIS, MAY BE BEGUN AGAINST PCI MORE THAN TWO (2) YEARS AFTER THE CAUSE OF ACTION AROSE.

Statutory Warranties – Some jurisdictions do not allow these limitations or exclusions, so they may not apply to you.

LIMITED WARRANTY (GARANTIE LIMITÉE)

Pour le Canada

GARANTIE LIMITÉE – ORDINATEURS ET PÉRIPHÉRIQUES PANASONIC

Couverture – Panasonic Canada Inc. (« PCI ») garantit à l'acheteur original que ce produit informatique (à l'exclusion des supports des logiciels) est, au moment de sa vente par PCI ou d'un revendeur agréé par PCI, exempt de défauts de pièces et de fabrication dans les conditions normales d'utilisation, et ce, pendant la période de couverture de la garantie, sous réserve des modalités décrites ci-dessous.

Éléments couverts	Durée de couverture	Type de couverture
<ul style="list-style-type: none"> • Ordinateurs blocs-notes (sauf batteries) et adaptateur secteur • Options installées en usine/par PCI incluant : WAN sans fil, GPS, Bluetooth, lecteur d'empreintes digitales, clavier rétroéclairé, carte mémoire et lecteurs (disquettes, CD/DVD) • Écran mobile sans fil • Ensembles PDRC – ACL et clavier • Duplicateur de port 	Trois (3) ans à partir de la date d'achat original.	Défauts de pièces et de fabrication
<ul style="list-style-type: none"> • Ordinateurs de poche • Batterie • Chargeur de batterie • Adaptateur pour voiture • Périphériques USB 	Un (1) an à partir de la date d'achat original.	Défauts de pièces et de fabrication
<ul style="list-style-type: none"> • Stylo pointeur standard ou pour numériseur graphique 	Quatre-vingt-dix (90) jours à partir de la date d'achat original.	Défauts de pièces et de fabrication
<ul style="list-style-type: none"> • Tous les articles consommables incluant les pellicules protectrices, chiffons de nettoyage, étuis de transport, longes et sangles 	Aucune couverture	

Recours – Pour obtenir des informations sur la marche à suivre dans le cas où une réclamation en vertu de la garantie deviendrait nécessaire, communiquez par téléphone avec un représentant de PCI au 1-800-668-8386, entre 9h00 et 17h00 (heure de l'Est) du lundi au vendredi (sauf les jours fériés), avant l'échéance de la garantie applicable, en prenant soin d'identifier la nature de la défaillance. Un reçu ou toute autre pièce justificative de la date d'achat original sera exigé avant toute réparation. Toute pièce défectueuse couverte par la présente garantie limitée sera réparée ou remplacée par une pièce neuve ou remise à neuf. Le remplacement ou la réparation sera fait conformément aux modalités de la présente garantie limitée pendant la durée restante de la période originale de la garantie.

Produits non couverts – La présente garantie limitée ne couvre pas les produits achetés à l'extérieur du Canada. Elle ne couvre pas non plus les dommages, la défaillance ou les défauts attribuables à une manutention inadéquate, une mauvaise installation, une utilisation anormale ou abusive, de la négligence, un accident, un déversement ou la pénétration d'un objet étranger, une modification, un cas fortuit ou une réparation effectuée par une personne non agréée par PCI.

CE PRODUIT N'EST PAS DESTINÉ À ÊTRE UTILISÉ, EN TOUT OU EN PARTIE, COMME SYSTÈME/ÉQUIPEMENT NUCLÉAIRE, SYSTÈME/ÉQUIPEMENT DE CONTRÔLE DU TRAFFIC AÉRIEN OU SYSTÈME/ÉQUIPEMENT DE POSTE DE PILOTAGE D'AVION³. PANASONIC DÉCLINE TOUTE RESPONSABILITÉ CONCERNANT L'UTILISATION DE CE PRODUIT DANS LES CAS SUSMENTIONNÉS.

³ Les SYSTÈMES/ÉQUIPEMENTS DE POSTE DE PILOTAGE D'AVION sont dotés de systèmes OEPP (organiseur électronique de poste de pilotage) de classe 2 et de classe 1 utilisés pendant des phases critiques de vol (par exemple, pendant le décollage et l'atterrissage) et/ou montés sur l'avion. Les systèmes OEPP de classe 1 et de classe 2 sont définis par le circulaire d'information FAA: AC (Advisory Circular) 120-76A ou le feuillet n° 36 JAA: JAA TGL (Temporary Guidance Leaflets) No 36.

EXPÉDITION DU PRODUIT POUR SERVICE SOUS GARANTIE

Emballer soigneusement le produit, de préférence dans son emballage d'origine. Joignez une description de la défaillance de même qu'une pièce justificative de la date d'achat. Panasonic Canada Inc. ne peut être tenue responsable pour tout dommage ou perte subi pendant le transport si vous avez choisi le transporteur.

GARANTIE LIMITÉE – SUPPORTS DES LOGICIELS

Couverture – Panasonic Canada Inc. (« PCI ») garantit à l'acheteur original que la ou les disquettes ou tout autre support sur lequel le ou les programmes sont fournis sont exempts de défauts de pièces et de fabrication dans des conditions normales d'utilisation au Canada, et ce, pour une période de soixante (60) jours suivant la date de réception indiquée sur la preuve d'achat. LA PRÉSENTE GARANTIE EST LA SEULE OFFERTE PAR PCI COUVRANT LES SUPPORTS DE LOGICIELS. PCI ne garantit pas les logiciels. Reportez-vous à la garantie écrite du concédant de licence d'utilisation du logiciel (qui accompagne la copie du logiciel) pour toute réclamation en vertu de la garantie.

Réclamation – marche à suivre – Panasonic Canada Inc. remplacera toute disquette ou support défectueux si l'article en question est retourné, port payé, à son service de Marketing – produits informatiques, 5770 Ambler Drive, Mississauga (Ontario) L4W 2T3, dans les soixante (60) jours suivant la date d'achat original. Joignez à votre envoi une pièce justificative de votre achat et une description du problème.

Recours – La responsabilité de PCI - et votre seul recours - dans le cas de toute défaillance couverte par la garantie sur ce support de logiciel est limitée au seul remplacement du support. Elle ne couvre aucun autre dommage, y compris, mais non exclusivement, la perte d'usage ou de profits, ni aucun dommage spécial, indirect ou consécutif, ni aucune autre réclamation de nature similaire ou autre.

Produits non couverts – La présente garantie limitée ne s'applique pas si la ou les disquettes ou autre support ont été utilisés dans un produit d'une marque autre que Panasonic ou dans des conditions environnementales autres que celles spécifiées par PCI ou le fabricant, ou soumis à une mauvaise utilisation, à la négligence, à une manutention inadéquate ou encore si le programme a été modifié ou subi une tentative de modification ou des dommages attribuables à un accident ou à un cas fortuit. De plus, PCI n'assume aucune responsabilité pour toute perte de, ou tout dommage à, un programme, des données ou un support de sauvegarde amovible.

GÉNÉRALITÉS

PCI NE RECONNAÎT AUCUNE AUTRE GARANTIE, EXPLICITE OU IMPLICITE, Y COMPRIS, MAIS NON EXCLUSIVEMENT, LES GARANTIES IMPLICITES DE VALEUR COMMERCIALE ET D'UTILITÉ À UNE FIN QUELCONQUE, À L'ÉGARD DU LOGICIEL, SUPPORTS DE LOGICIELS, PRODUITS INFORMATIQUES, PÉRIPHÉRIQUES ET ACCESSOIRES.

SOUS AUCUNE CIRCONSTANCE PCI NE POURRA ÊTRE TENUE RESPONSABLE DES DOMMAGES SPÉCIAUX, INDIRECTS OU CONSÉCUTIFS ATTRIBUABLES À UN MANQUEMENT AUX GARANTIES LIMITÉES DÉCRITES DANS LE PRÉSENT DOCUMENT OU À L'UTILISATION DU PRODUIT INFORMATIQUE, Y COMPRIS, SANS RESTRICTION, LA PERTE DE DONNÉES, D'AFFAIRES, D'ACHALANDAGE OU DE PROFIT.

DANS TOUS LES CAS, LA RESPONSABILITÉ MAXIMALE DE PCI POUR TOUT MANQUEMENT NE POURRA EXCÉDER LE PRIX DE VENTE DU PRODUIT INFORMATIQUE.

AUCUNE RÉCLAMATION, SANS ÉGARD À SES MOTIFS, NE POURRA ÊTRE FAITE AUPRÈS DE PCI PLUS DE DEUX (2) ANS APRÈS LES FAITS INVOQUÉS À LA BASE D'UNE TELLE RÉCLAMATION.

Garantie statutaires – Certaines juridictions interdisent de telles limitations ou exclusions; aussi, pourraient-elles ne pas s'appliquer.

For Australia

Personal / Notebook Computers - 36 Month Warranty from Date of Purchase

1. Subject to the conditions of this warranty Panasonic or its Authorised Service Centre will perform necessary service on the product without charge for parts or labour, if in the opinion of Panasonic, the product is found to be faulty within the warranty period.
2. This warranty only applies to Panasonic products purchased in Australia and sold by Panasonic Australia or its Authorised Distributors or Dealers and only where the products are used and serviced within Australia or its territories. Warranty cover only applies to service carried out by a Panasonic Authorised Service Centre and only if valid proof of purchase is presented when warranty service is requested.
3. This warranty only applies if the product has been installed and used in accordance with the manufacturer's recommendations (as noted in the operating instructions) under normal use and reasonable care (in the opinion of Panasonic). The warranty covers normal domestic use only and does not cover damage, malfunction or failure resulting from use of incorrect voltages, incorrect installation, accident, misuse, neglect, build-up of dirt or dust, abuse, maladjustment of customer controls, mains supply problems, thunderstorm activity, infestation by insects or vermin, tampering or repair by unauthorised persons (including unauthorised alterations), exposure to abnormally corrosive conditions or any foreign object or matter having entered the product.
4. This warranty does not cover the following items unless the fault or defect existed at the time of purchase: Software
5. Warranty on Toughbook accessories (stylus, pens, AC charger, combo drive, etc) is 12 Months from the date of purchase & 3 months for batteries.
6. To claim warranty service, when required, you should:
Check the Panasonic web site for latest warranty contact <http://www.panasonic.com/au/business/computers-tablets-and-pos/toughbook.html>, use the Service Centre Locator and call the National Service Centre number indicated.
Prepare purchase receipt as proof of purchase date and system serial number which will be required by the Authorised Service Centre.
7. The Warranty excludes 3 or less faulty pixels on screen.
8. The Warranty includes the repair or exchange of faulty parts within the product with items that are functionally equivalent to that as originally supplied or better – including new or refurbished parts or units – solely at Panasonic's discretion.
9. It is the customer's responsibility to backup all data from the hard disk drive before sending equipment for repair. If a problem is related to the hard disk drive, or the hard disk drive has to be replaced, Panasonic will only reload the factory pre-installed software for the product onto the replacement drive.
10. Panasonic will arrange free pick up and return for approved warranty repairs within 50 km of capital city locations. Please ensure your unit is properly packed for return to the service location.
11. The warranties hereby conferred do not extend to, and exclude, any costs associated with the installation, de-installation or re-installation of a product, including costs related to the mounting, demounting or remounting of any screen, (and any other ancillary activities), delivery, handling, freighting, transportation or insurance of the product or any part thereof or replacement of and do not extend to, and exclude, any damage or loss occurring by reason of, during, associated with, or related to such installation, de-installation, re-installation or transit.

In addition to your rights under this warranty, Panasonic products come with consumer guarantees that cannot be excluded under the Australian Consumer Law. If there is a major failure with the product, you can reject the product and elect to have a refund or to have the product replaced or if you wish you may elect to keep the goods and be compensated for the drop in value of the goods. You are also entitled to have the product repaired or replaced if the product fails to be of acceptable quality and the failure does not amount to a major failure.

If there is a major failure in regard to the product which cannot be remedied then you must notify us within a reasonable period by contacting the Panasonic Customer Care Centre. If the failure in the product is not a major failure then Panasonic may choose to repair or replace the product and will do so in a reasonable period of time from receiving notice from you.

THIS PRODUCT IS NOT INTENDED FOR USE AS OR AS PART OF NUCLEAR EQUIPMENT/SYSTEMS, AIR TRAFFIC CONTROL EQUIPMENT/SYSTEMS, OR AIRCRAFT COCKPIT EQUIPMENT/SYSTEMS⁴. PANASONIC WILL NOT BE RESPONSIBLE FOR ANY LIABILITY RESULTING FROM THE USE OF THIS PRODUCT ARISING OUT OF THE FOREGOING USES.

⁴ AIRCRAFT COCKPIT EQUIPMENT/SYSTEMS include Class 2 Electronic Flight Bag (EFB) Systems and Class 1 EFB Systems when used during critical phases of flight (e.g., during take-off and landing) and/or mounted onto the aircraft. Class 1 EFB Systems and 2 EFB Systems are defined by FAA: AC (Advisory Circular) 120-76A or JAA: JAA TGL (Temporary Guidance Leaflets) No.36.

THIS WARRANTY CARD AND THE PURCHASE DOCKET (OR SIMILAR PROOF OF PURCHASE)
SHOULD BE RETAINED BY THE CUSTOMER AT ALL TIMES

If you require assistance regarding warranty conditions or any other enquiries, please visit the
Panasonic Australia website
<http://www.panasonic.com/au/business/computers-tablets-and-pos/toughbook.html>, or
contact by phone on **1300 132 463**

Panasonic Australia Pty. Limited

ACN 001 592 187 ABN 83 001 592 187

1 Innovation Road, Macquarie Park NSW 2113

www.panasonic.com.au

PRO-031-F05 Issue: 4.0

11-11-2011



As an ENERGY STAR® Partner, Panasonic Corporation has determined that this product meets the ENERGY STAR® guidelines for energy efficiency. By enabling available power management settings, Panasonic computers enter a low-power sleep mode after a period of inactivity, saving the user energy.

<For U.S.A.>

To learn more about power management, please visit the web site:

www.energystar.gov/index.cfm?c=power_mgt.pr_power_management

Outline of the International ENERGY STAR® Office Equipment Program

The international ENERGY STAR® Office Equipment Program is an international program that promotes energy saving through the use of computers and other office equipment. The program backs the development and dissemination of products with functions that effectively reduce energy consumption. It is an open system in which business proprietors can participate voluntarily. The targeted products are office equipment such as computers, displays, printers, facsimiles, and copiers. Their standards and logos are uniform among participating nations.

<For U.S.A.>

For information about ENERGY STAR®, refer to the following web site:

Web Site: www.energystar.gov

22-E-1

Panasonic Corporation

Osaka, Japan

Panasonic System Communications Company of North America

Two Riverfront Plaza

Newark, NJ 07102

Panasonic Canada Inc.

5770 Ambler Drive, Mississauga,

Ontario L4W 2T3

Panasonic Australia Pty. Limited

ACN 001 592 187 ABN 83 001 592 187

1 Innovation Road, Macquarie Park NSW 2113

Importer's name & address pursuant to the EU legislation

Panasonic System Communications Company Europe, Panasonic Marketing Europe GmbH

Hagenauer Straße 43

65203 Wiesbaden

Germany

Web Site : <http://panasonic.net/>