

ASTRO[®]

XTS[™] 2500 & XTS[™] 2500I

Model 3

User Guide



ASTRO® XTS 2500/XTS 2500I

Digital Portable Radio

Quick Reference Card

Product Safety and RF Exposure Compliance



Before using this product, read the operating instructions for safe usage contained in the Product Safety and RF Exposure booklet enclosed with your radio.

ATTENTION!

This radio is restricted to occupational use only to satisfy FCC RF energy exposure requirements. Before using this product, read the RF energy awareness information and operating instructions in the Product Safety and RF Exposure booklet enclosed with your radio (Motorola Publication part number 6881095C98) to ensure compliance with RF energy exposure limits.

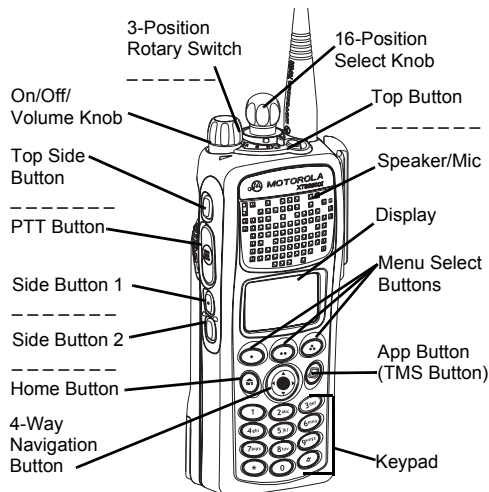

Write your radio's programmed features on the dotted lines.

Select a Zone Using the Menu

- 1 Press until
- 2 Press , , or directly below ZONE.
- 3 Press until the zone you desire is shown
OR
Use the **keypad** directly to dial the zone number.
- 4 Press to confirm, or press **PTT** to transmit.

Select a Channel

Method 1: Using the Select Knob

After selecting the desired zone, turn the 16-position Select Knob to the desired channel.

Method 2: Using the Menu

- 1 Press until
- 2 Press , , or directly below CHAN.
- 3 Press until channel you desire is shown.
- 4 Press to confirm, or press **PTT** to transmit.

Send an Emergency Alarm

- 1 Turn the radio ON and press **Emergency** button. You will see a red LED; you hear a short, medium-pitched tone.
- 2 Display shows
- 3 When acknowledgment is received, you hear four tones; alarm ends; radio exits emergency.

Send Silent Emergency Alarm

- 1 Turn the radio ON and press **Emergency** button. You will see no LED; you will hear no tone.
- 2 Press **PTT**.
- 3 Alarm continues until you exit by:
 - Press and hold **Emergency** button for one second.**OR**
 - Press **PTT** again.











Answer a Phone Call



- 1 Phone-like ringing, LED blinks GREEN, PHONE CALL and are displayed.
- 2 Press **Call Response** button.
- 3 Press **PTT** button to talk; release to listen.
- 4 Press to hang up.

Send a Phone Call

- 1 Press until
- 2 Press , , or directly below PHON.
- 3 Press or to scroll to phone number.
- 4 Press **PTT** (or **Quick Access** button, if programmed) to talk, release to listen.

Display Status Symbols

	Call Received. Receiving an individual call.
	View/Program Mode. The radio is in the view or program mode; On Steady = view mode; Blinking = program mode.
	Received Signal Strength Indication (RSSI). Received signal strength for the current site (trunking only). The more signal bars in the symbol, the stronger the signal.
	Battery <ul style="list-style-type: none"> Conventional = Blinks when the battery is low. Smart = The number of bars (0-3) shown indicates the charge remaining in your battery. Note: Smart battery will be available at a future date.
	Talkaround. You are talking directly to another radio or through a repeater; On = direct; Off = repeater
	Monitor (Carrier Squelch). This channel is being monitored.
	Scan. The radio is scanning a scan list.
  	User Login Indicator (IP Packet Data) <ul style="list-style-type: none"> On = User is associated with the radio; Off = User is not associated with the radio; Blinking = Registration with the server failed.

 	Location Signal <ul style="list-style-type: none"> Off = Location feature disabled, or insufficient battery power in location accessory device; Blinking = Location feature enabled, but no location signal available; On = Location feature enabled, and location signal available.
---	--

Menu Entries (Use With Menu Navigation)

<i>Entry</i>	<i>Menu Selection</i>	<i>Page</i>
BATT	*Smart Battery	19
CALL	Private Call	60
CHAN	Select a Channel	28
CLOCK	Edit Time and Date	78
DIR	Repeater/Direct	66
KILL	Radio Kill	67
MUTE	Keypad Mute	37
NAME	Text Select	49

<i>Entry</i>	<i>Menu Selection</i>	<i>Page</i>
NUM	Number Select	47
PAGE	Call Alert Page	62
PHON	Phone	55
PROG	Editing	47
PSWD	Password	36
RPGM	Reprogram Request	71
SCAN	Scan On/Off	51
SITE	Site Lock	75
STUN	Radio Stun	68
TGRP	Talkgroup Call	65
TMS	Text Messaging	93
USER	User Login	87
VIEW	Viewing a List	45
ZONE	Select a Zone	26

*Available at a future date.

Menu Navigation

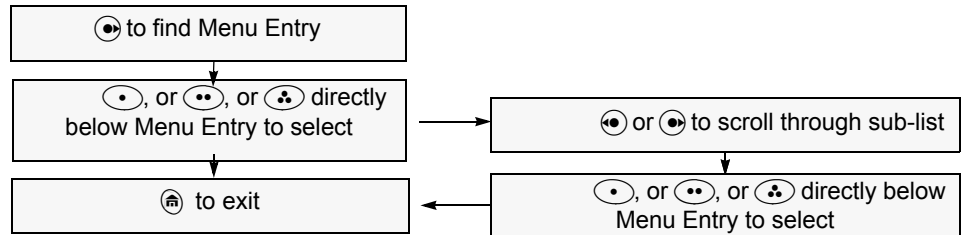

This declaration is applicable to your radio *only* if your radio is labeled with the FCC logo shown below.

DECLARATION OF CONFORMITY

Per FCC CFR 47 Part 2 Section 2.1077(a)



Responsible Party

Name: Motorola, Inc.

Address: 1301 East Algonquin Road, Schaumburg, IL 60196-1078, USA

Phone Number: 1-800-927-2744

Hereby declares that the product:

Model Name: **XTS 2500 / XTS 2500I**

conforms to the following regulations:

FCC Part 15, subpart B, section 15.107(a), 15.107(d) and section 15.109(a)

Class B Digital Device

As a personal computer peripheral, this device complies with Part 15 of the FCC Rules. Operation is subject to the following two conditions:

1. this device may not cause harmful interference, and
2. this device must accept any interference received, including interference that may cause undesired operation.

Note: This equipment has been tested and found to comply with the limits for a Class B digital device, pursuant to part 15 of the FCC Rules. These limits are designed to provide reasonable protection against harmful interference in a residential installation. This equipment generates, uses and can radiate radio frequency energy and, if not installed and used in accordance with the instructions, may cause harmful interference to radio communications. However, there is no guarantee that interference will not occur in a particular installation.

If this equipment does cause harmful interference to radio or television reception, which can be determined by turning the equipment off and on, the user is encouraged to try to correct the interference by one or more of the following measures:

- Reorient or relocate the receiving antenna.
- Increase the separation between the equipment and receiver.
- Connect the equipment into an outlet on a circuit different from that to which the receiver is connected.
- Consult the dealer or an experienced radio/TV technician for help.

Product Safety and RF Exposure Compliance



Before using this product, read the operating instructions for safe usage contained in the Product Safety and RF Exposure booklet enclosed with your radio.

ATTENTION!

This radio is restricted to occupational use only to satisfy FCC RF energy exposure requirements. Before using this product, read the RF energy awareness information and operating instructions in the Product Safety and RF Exposure booklet enclosed with your radio (Motorola Publication part number 6881095C98) to ensure compliance with RF energy exposure limits.

For a list of Motorola-approved antennas, batteries, and other accessories, visit the following web site which lists approved accessories: <http://www.motorola.com/governmentandenterprise>

Computer Software Copyrights

The Motorola products described in this manual may include copyrighted Motorola computer programs stored in semiconductor memories or other media. Laws in the United States and other countries preserve for Motorola certain exclusive rights for copyrighted computer programs, including, but not limited to, the exclusive right to copy or reproduce in any form the copyrighted computer program. Accordingly, any copyrighted Motorola computer programs contained in the Motorola products described in this manual may not be copied, reproduced, modified, reverse-engineered, or distributed in any manner without the express written permission of Motorola. Furthermore, the purchase of Motorola products shall not be deemed to grant either directly or by implication, estoppel, or otherwise, any license under the copyrights, patents or patent applications of Motorola, except for the normal non-exclusive license to use that arises by operation of law in the sale of a product.

Documentation Copyrights

No duplication or distribution of this document or any portion thereof shall take place without the express written permission of Motorola. No part of this manual may be reproduced, distributed, or transmitted in any form or by any means, electronic or mechanical, for any purpose without the express written permission of Motorola.

Disclaimer

The information in this document is carefully examined, and is believed to be entirely reliable. However, no responsibility is assumed for inaccuracies. Furthermore, Motorola reserves the right to make changes to any products herein to improve readability, function, or design. Motorola does not assume any liability arising out of the applications or use of any product or circuit described herein; nor does it cover any license under its patent rights, nor the rights of others.

Notes

Important Rebanding Information

This radio supports the new FCC 800 MHz Public Safety frequency band definition. The FCC has reorganized the 800 MHz band to reduce particular types of interference impacting public safety radio systems by moving the NPSPAC transmit frequencies from 821-824MHz to the 806-809 MHz area. This change consolidates 700 MHz and 800 MHz public safety transmit frequencies into a single contiguous block of spectrum with a greater degree of separation from cellular and Enhanced SMR frequencies. This separation should limit any harmful out-of-band emission and receiver intermodulations.

Note: In accordance with the FCC 800 MHz rebanding Report and Order (Docket 02-55), Motorola has offered rebanding replacement products to allow 800 MHz licensees to comply with the new band plan. These rebanding products are part of Motorola's current ASTRO Digital XTS and XTL product portfolio and are denoted by an RB at the end of the product title. These products offer all of the features of the current products but have the channel capacity and call list sizes equivalent to the MTS 2000 and MCS 2000 products.

Notes

Contents

Declaration of Conformity	i
Product Safety and RF Exposure Compliance	ii
Computer Software Copyrights	ii
Documentation Copyrights	iii
Disclaimer	iii
Notes	iv
Important Rebanding Information	v
General Radio Operation	1
Notations Used in This Manual	1
XTS 2500 / XTS 2500I Model III Radio	2
Physical Features of the XTS 2500 / XTS 2500I Model III Radio	3
Programmable Features	4
Display	5
Backlight	5
Status Symbols	6
Menu Entry (Softkey)	8
Menu Select Buttons	8
Menu Entry Features	9
Home Button (🏠)	10
App Button (TMS Feature Button)	10
4-Way Navigation Button (🕒)	10
Keypad	11
LED Indicators	12
Alert Tones	13
Standard Accessories	17
Battery	17
Smart Battery Condition	19
Antenna	20
Belt Clip	21
Universal Connector Cover	22
Remote Speaker Microphone Adapter	23
Radio On and Off	25
Turn the Radio On	25
Turn the Radio Off	25
Zones and Channels	26
Select a Zone	26
Select a Channel	28

Mode Select Button	30
Receive / Transmit	31
Without Using the Volume Set and Monitor Buttons	31
Use Preprogrammed Volume Set Button	32
Use the Preprogrammed Monitor Button	33
Conventional Mode Operation	34
Common Radio Features	35
Radio Lock	35
Unlock Your Radio	35
Change Your Password	36
Mute or Unmute Keypad Tones	37
Use the Menu	37
Using the Preprogrammed Side Button	37
Conventional Squelch Options	38
Analog Squelch	38
Digital Squelch	38
PL Defeat	39
Time-out Timer	40
Emergency	41
Send an Emergency Alarm	41
Send an Emergency Call	42
Send a Silent Emergency Alarm	43
Emergency Keep-Alive	44
Lists	45
View a List	45
Scan List Empty	46
Edit a Call, Page, or Phone List Number	47
Use the Menu	47
Edit a Call, Page, or Phone List Name	49
Use the Menu	49
Scan	51
Turn Scan On and Off	51
Delete a Nuisance Channel	53
Conventional Scan Only	54
Telephone Calls (Trunking Only)	55
Answer a Phone Call	55
Make a Phone Call	56
Phone Call Display and Alert Prompts	58
Private Calls (Trunking Only)	59
Answer a Private Call	59
Make a Private Call	60

Call Alert Paging	62
Answer a Call Alert Page	62
Make a Call Alert	63
Conventional Talkgroup Calls (Conventional Operation Only)	65
Select Talkgroup	65
Repeater or Direct Operation	66
Select Repeater or Direct Operation	66
Special Radio Features	67
Radio Kill	67
Remote Kill	67
Direct Kill	67
Radio Stun	68
PTT ID	69
Receive	69
Transmit	69
View Your Radio's ID Number	70
Dynamic Regrouping (Trunking Only)	71
Reprogram Request (ASTRO 25 Trunking Only)	71
Select Enable / Disable	73
Trunking System Controls	74
Failsoft	74
Out-of-Range	74
Site Lock	75
Site Trunking	76
Site View and Change	76
Time and Date	78
Edit Time and Date	78
Outdoor Location (using GPS)	80
Access the Location feature	80
GPS Enabled	82
ARS User Login and Text Messaging Features	85
Automatic Registration Service (ARS)	85
Selecting or Changing ARS Mode	85
ARS User Login Feature	87
Accessing the User Login Feature	87
To Login as a User	88
Selecting a Predefined Username	92
Text Messaging	93
Accessing TMS Feature	93

Receive a Message	98
To View Message from the Inbox.	98
Compose a New Text Message	99
.....	100
Send a Predefined Message	102
Edit a Quick Text Message	103
Reply to a Received Message	104
Delete a Message	104
To Access the Draft Folder	105
To Access the Sent Folder	106
Helpful Tips	107
Radio Care	107
Cleaning	107
Handling	107
Service	107
Battery	108
Battery Life	108
Charging the Battery	108
Battery Recycling and Disposal	110
Antenna	111
Radio Operating Frequencies	111
Accessories	113
Antennas	113
Batteries	114
Carry Accessories	114
Belt Clips	114
Body-Worn	114
Chargers	115
Enhanced and Multi-Unit Line Cords	115
Microphones, Remote Speaker	116
Surveillance Accessories	117
Adapters and Adapter Cable	117
CommPort® Integrated Microphone/Receivers	117
Earpieces	117
Headsets and Headset Accessories	119
Radio Interface Modules for Ear Microphones	119
Switches	119

Appendix: Maritime Radio Use in the VHF Frequency Range 121

Special Channel Assignments 121

 Emergency Channel 121

 Non-Commercial Call Channel 122

Operating Frequency Requirements 122

Glossary 125

Commercial Warranty 129

Index 135

Table 1: Channel Map

Use the chart below to map the channels (Cx) and zones (Zx) for your radio.

	Z1	Z2	Z3	Z4	Z5	Z6
C1						
C2						
C3						
C4						
C5						
C6						
C7						
C8						
C9						
C10						
C11						
C12						
C13						
C14						
C15						
C16						

General Radio Operation

Notations Used in This Manual

You will notice the use of **WARNING**, **CAUTION**, and **Note** throughout this manual. These notations are used to emphasize that safety hazards exist and that care must be taken or observed.



WARNING

WARNING: An operational procedure, practice, condition, etc. exists which may result in injury or death if not carefully observed.





Caution

CAUTION: An operational procedure, practice, condition, etc. exists which may result in damage to the equipment if not carefully observed.

Note: A **Note** is an operational procedure, practice, or condition, etc. which is essential to emphasize.

The following special notations identify certain items:

Example	Description
Light button, or 	Buttons and keys are shown in bold print, or as representative symbols.
	Information appearing in the radio's display is shown using the special display font.
PHONE	Menu entries are shown similar to the way they appear in the radio's display.
Press 	This means "Press the right side of the 4-Way Navigation button."

XTS 2500 / XTS 2500I Model III Radio

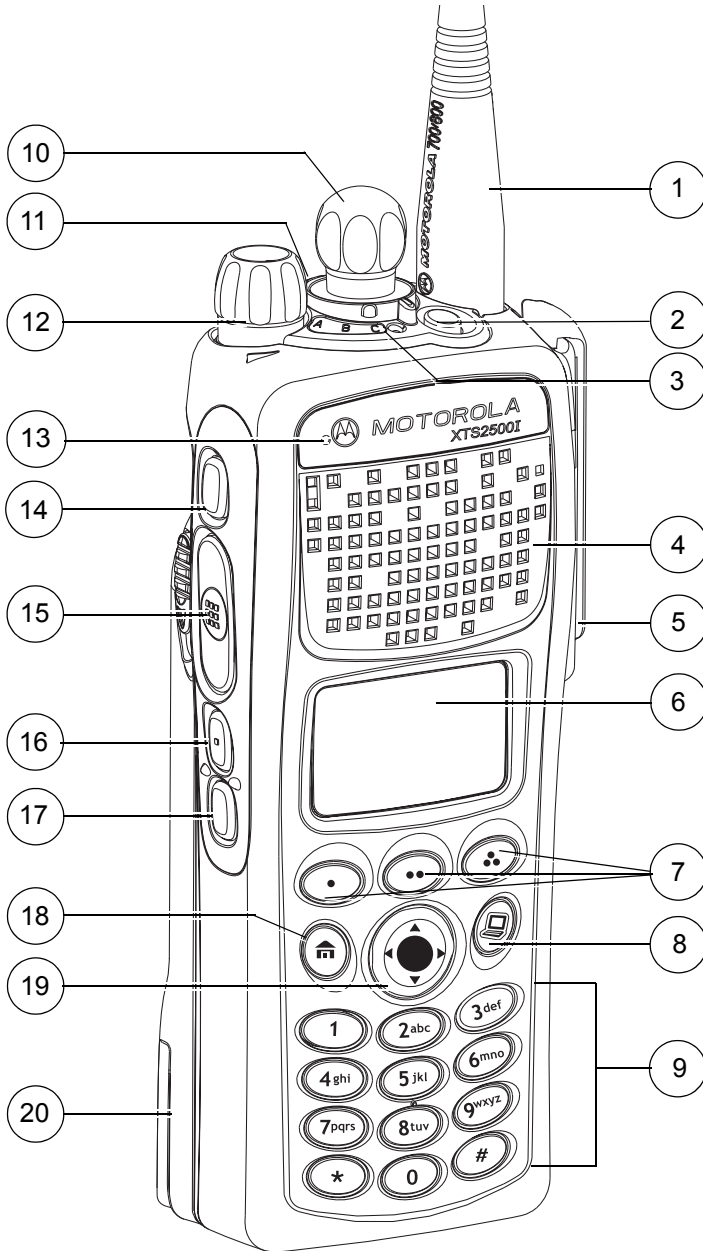

Physical Features of the XTS 2500 / XTS 2500I Model III Radio

Item	Page	Item	Page
1 Antenna	20	11 3-Position Concentric Switch (programmable)	-
2 Top Button (programmable)	-	12 On/Off/Volume Control Knob	25
3 LED	12	13 Microphone	-
4 Speaker	-	14 Top Side (Select) Button (programmable)	-
5 Universal Connector	22	15 Push-to-Talk (PTT) Button	-
6 Display	5	16 Side Button 1 (programmable)	-
7 Menu Select Buttons	8	17 Side Button 2 (programmable)	-
8 App Button	10	18 Home Button	10
9 Keypad	11	19 4-Way Navigation Button	10
10 16-Position Knob (programmable)	-	20 Battery	17

Programmable Features

The programmable controls on your radio can be programmed by a qualified technician to operate certain software-activated features. The features that can be assigned to these controls, and the page numbers where these features can be found, are listed below.

Table 1: Programmable Features

Feature	Page	Feature	Page
Call Alert Page	62	Radio Kill	67
Call Response	55	Radio Stun	68
Channel Selection	28	Repeater/Direct	66
Dynamic Priority	54	Reprogram Request	71
Emergency	41	Scan On/Off	51
Keypad Mute	37	Site Lock/Unlock	75
Light	5	Site Search	76
Monitor	33	*Smart Battery	19
Nuisance Delete	53	Text Messaging	93
Outdoor Location	80	TMS Quick Text	92
Phone	55	User Login	87
PL Defeat	39	Volume Set	31
Private Call	59	Zone Selection	26

*Available at a future date.

Any references in this manual to controls that are “preprogrammed” means that a qualified technician must use the radio’s programming software to assign a feature to the control.

Display

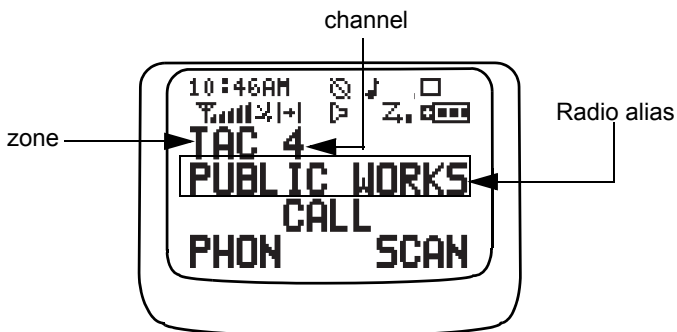

This figure is typical of what you see on your radio. The 64 x 96 pixel liquid crystal display (LCD) shows radio status, text, and menu entries.

Backlight

If poor light conditions make the display and keypad difficult to read, turn on the radio's backlights by pressing the preprogrammed **Light** button.

These lights will remain on for a preprogrammed time before they turn off automatically. You can also turn them off immediately by pressing the **Light** button again.

Status Symbols

The top two rows in the display contain symbols indicating the radio's status.

Table 2: Status Symbols









Symbol	Indication	Page
	Call Received. Blinks when an Individual Call is received.	59
	View/Program Mode. <ul style="list-style-type: none"> View a list (steady). Program a list (blinking). 	45
	Received Signal Strength Indication (RSSI). The received signal strength for the current site. Trunked only. The more signal bars in the symbol, the stronger the received signal.	76
	Battery <ul style="list-style-type: none"> Conventional = Blinks when the battery is low. Smart = The number of bars (0-3) shown indicates the charge remaining in your battery. Blinks when battery level reaches 10% or less. Note: Smart battery will be available at a future date.	17
	Talkaround. <ul style="list-style-type: none"> On = Talking directly to another radio, not through a repeater. Conventional operation only. Off = Talking through a repeater. 	66
	Monitor (Carrier Squelch). The selected channel is being monitored. Conventional operation only.	33
	Scan. The radio is scanning a scan list.	51

Table 2: Status Symbols (Continued)

Symbol	Indication	Page
	<p>User Login Indicator (IP Packet Data)</p> <ul style="list-style-type: none"> • On (Tinted) = User is currently associated with the radio; • Off (Not tinted) = User is currently not associated with the radio; • Blinking = Device registration or user registration with the server failed due to an invalid username or pin. 	90
	<p>Location Signal</p> <ul style="list-style-type: none"> • Off = Location feature disabled, or insufficient battery power in location accessory device; • Blinking = Location feature enabled, but no location signal available; • On = Location feature enabled, and location signal available. 	80

Menu Entry (Softkey)

The bottom row of the display contains one to three menu entries (also known as softkeys). The menu entries allow you to select from one of several menus to access the radio's features. The menu entries are accessed using the **Menu Select** buttons.

Menu Select Buttons

The **Menu Select** buttons access the menu entries of features that have been activated by a qualified radio technician. Your radio may be programmed differently from the following example, but the display for selecting Scan on or off might look like this:

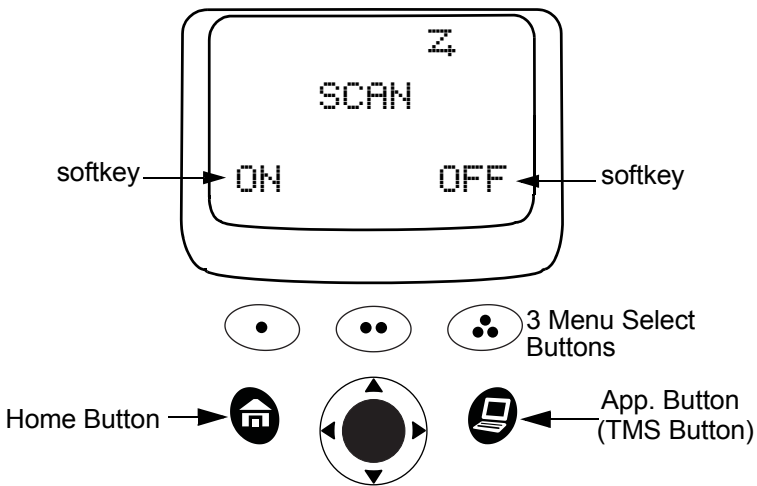

Example: To turn scan on:

Press .

The display shows the selected state.

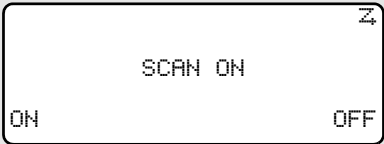

The example shows the result of pressing the first menu select button. The display now shows "SCAN ON" in the center. Below "SCAN ON", the words "ON" and "OFF" are positioned. The radio icon from the previous diagram is still in the top right corner. The background of this example is a light gray box.

Menu Entry Features

In most cases, press  to display the following feature selections.

Table 3: Menu Entry Features

Feature	Menu Entry	Page	Feature	Menu Entry	Page
Call Alert Page	PAGE	63	Reprogram Request	RPGM	71
Channel Selection	CHAN	28	Scan On/Off	SCAN	51
Edit a List	PROG	47, 49	Site Lock/Unlock	SITE	75
Keypad Mute	MUTE	37	Smart Battery*	BATT	19
Number Select	NUM	47	Talkgroup Call	TGRP	65
Password	PSWD	36	Text Select	NAME	49
Phone	PHON	56	Text Messaging	TMS	93
Private Call	CALL	60	Time/Date	CLCK	78
Radio Lock	RADIO LOCKED	35	User Login	USER	87
Radio Kill	KILL	67	View a List	VIEW	45
Radio Stun	STUN	68	Zone Selection	ZONE	26
Repeater/Direct	DIR	66			

*Available at a future date.

Home Button (🏠)

The **Home** button will always return you to the home (default) display. In most cases, this is the current mode.

Some radio features that can be edited by you require saving information in memory. Pressing the **Home** button while using those features will cause information to be saved before going to the home display.

Some features do not require you to press the **Home** button to go to the home display. This reduces the required number of button presses.

App Button (TMS Feature Button)

This button brings you to the Text Messaging Service (TMS) feature screen.

4-Way Navigation Button (🕒)

This button is used to scroll through the radio's lists or items in the display.

Keypad

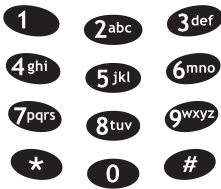

The 3 x 4 alphanumeric keypad provides an interface to your radio's features.

The keypad functions in a manner similar to a standard telephone keypad when entering numeric digits.

When the keypad is used to edit a list, each key can generate different characters of the alphabet. Refer to the following table for a complete list of characters.

Table 4: Keypad Character Editing Table

Key	Number of times the key is pressed								
	1	2	3	4	5	6	7	8	9
0	0	()	<	>				
1	1	&	%						
2abc	A	B	C	2	a	b	c		
3def	D	E	F	3	d	e	f		
4ghi	G	H	I	4	g	h	i		
5jkl	J	K	L	5	j	k	l		
6mno	M	N	O	6	m	n	o		
7pqrs	P	Q	R	S	7	p	q	r	s
8tuv	T	U	V	8	t	u	v		
9wxyz	W	X	Y	Z	9	w	x	y	z
*	*	/	+	-	=				
#	#	.	!	?	,	;			

LED Indicators

Table 5: LED Indicators

This LED Color:	Indicates:
RED (Illuminated)	Transmitting
RED (Blinking)	<ul style="list-style-type: none">• Channel Busy or <ul style="list-style-type: none">• Low Battery (lights while transmitting)
GREEN (Blinking)	Receiving Individual Call

Alert Tones

Your radio uses alert tones to inform you of radio conditions.

Table 6: Alert Tones

You hear:	Tone Name	Heard:
<i>Short, Low-Pitched Tone</i>	Invalid Key-Press	when the wrong key is pressed.
	Radio Self-Test Failed	when the radio fails the power-up self test.
	Reject	when an unauthorized request is made.
	Time-Out Timer Warning	four seconds before time out.
<i>Long, Low-Pitched Tone</i>	No ACK Received	when the radio does not receive an acknowledgment.
	Time-Out Timer Timed Out	after time out.
	Talk Prohibit/PTT Inhibit	(when the PTT button is pressed) transmissions are prevented.
	Out-of-Range	(when the PTT button is pressed) the radio is out of range of the system.
	Invalid Mode	when the radio is set to an unprogrammed channel.
	Individual Call Warning Tone	when the radio is in Individual Call without any activity for more than 6 seconds.

Table 6: Alert Tones (Continued)

You hear:	Tone Name	Heard:
<i>A Group of Low-Pitched Tones (Busy Tone)</i>	Busy	when the system is busy.
<i>Short, Medium-Pitched Tone</i>	Valid Key-Press	when the correct key is pressed.
	Radio Self-Test Pass	when the radio passes its power-up self-test.
	Priority Channel Received	when activity on a priority channel is received.
	Emergency Alarm Entry	when entering the emergency state.
	Central Echo	when the central controller has received a request from a radio.
<i>Long, Medium-Pitched Tone</i>	Volume Set	when volume changed on a quiet channel.
	Emergency Exit	upon exiting the emergency state.

Table 6: Alert Tones (Continued)

You hear:	Tone Name	Heard:
<i>A Group of Medium-Pitched Tones</i>	Failsoft	when the trunking system fails.
	Automatic Call Back	when the voice channel is available from the previous request.
	Talk Permit	(When pressing the PTT button) verifies the system is accepting transmissions.
	Console Acknowledge	when a status, emergency alarm, or reprogram request acknowledgment is received.
	Received Individual Call	when a Call Alert, or Private Conversation Call is received.
	Call Alert Sent	when a Call Alert is received by the target radio.
<i>A Group of Low-Pitched Tones followed by a group of High-Pitched Tones</i>	Scan Alert On	when the Scan feature is activated through the pre-programmed button or 3-Position Rotary Switch.
<i>A Group of High-Pitched Tones followed by a group of Low-Pitched Tones</i>	Scan Alert Off	when the Scan feature is deactivated through the pre-programmed button or 3-Position Rotary Switch.
<i>Short, High-Pitched Tone (Chirp)</i>	Low-Battery Chirp	when the battery is below the preset threshold value.

Table 6: Alert Tones (Continued)

You hear:	Tone Name	Heard:
<i>Ring</i>	Fast Ringing	when the system is searching for the Private Conversation Call target radio.
	Enhanced Call Sent	when waiting for the Private Conversation Call target radio to respond to the call.
	Phone Call Received	when a landline phone call is received.
<i>Gurgle</i>	Dynamic Regrouping	when the PTT button is pressed, a dynamic ID has been received.
<i>Unique, low-pitched chirp</i>	New Message	when a new message is received.
<i>Unique, high-pitched chirp</i>	Priority Message	when a priority message is received.

Standard Accessories

Battery



To avoid a possible explosion:

- **DO NOT** replace the battery in any area labeled “hazardous atmosphere”.
- **DO NOT** discard batteries in a fire.

Charge the Battery

The Motorola-approved battery shipped with your radio is uncharged. Prior to using a new battery, charge it for a minimum of 16 hours to ensure optimum capacity and performance.

For a list of Motorola-authorized batteries available for use with your XTS 2500 / XTS 2500I radio, see “Batteries” on page 114.

Note: When charging a battery attached to a radio, turn the radio off to ensure a full charge.

Battery Charger

To charge the battery, place the battery, with or without the radio, in a Motorola-approved charger. The charger’s LED indicates the charging progress; see your charger’s user guide. For a list of chargers, see “Chargers” on page 115.

Attach the Battery

- 1 With the radio off, fit the three extensions at the bottom of the battery into the bottom slots on the radio.

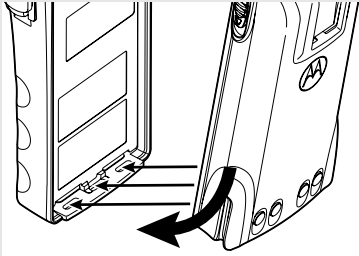

- 2 Press the top of the battery against the radio until both latches click into place.

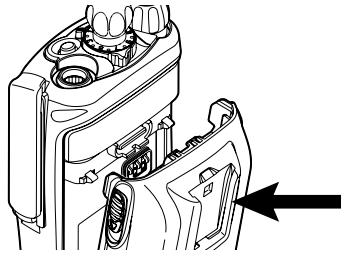

Remove the Battery

- 1 With the radio off, slide down the latches on the sides of the battery.

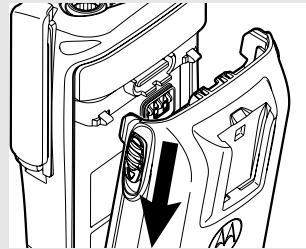

- 2 Pull the top of the battery away from the radio.

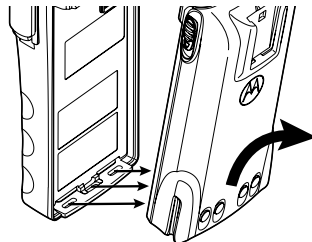



Smart Battery Condition

This feature allows you to view the condition of your Smart Battery.

Use the Menu

- 1 Press  to find BATT.

BATT

- 2 Press , , or  directly below BATT.

CAPACITY	70%
INIT	10/01
EST CHGS	11

Note: If a Smart Battery is not powering your radio.

SMART BATT
DATA NOT
AVAILABLE

- 3 Press  to exit.

Use the Preprogrammed Smart Battery Button

- 1 Press the **Smart Battery** button.

CAPACITY	70%
INIT	10/01
EST CHGS	11

Note: If a Smart Battery is not powering your radio.

SMART BATT
DATA NOT
AVAILABLE

- 2 Press  to exit.

Antenna

For information regarding other available antennas, see page 113.

Attach the Antenna

With the radio off, turn the antenna clockwise to attach it.

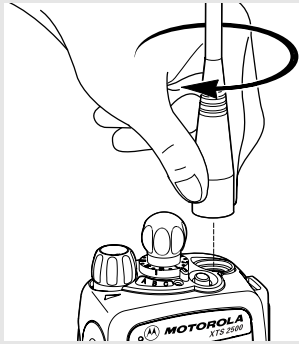

Remove the Antenna

With the radio off, turn the antenna counter-clockwise to remove it.

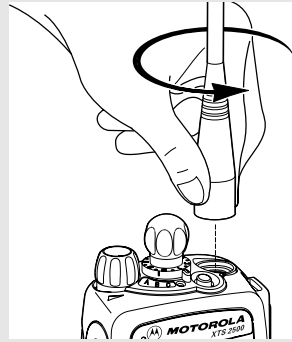

Belt Clip

Attach the Belt Clip

- 1 Align the grooves of the belt clip with those of the battery.

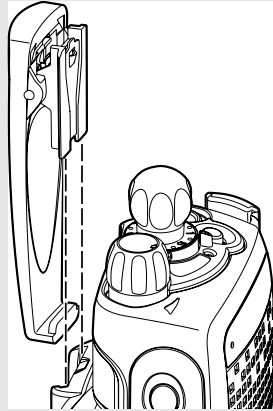

- 2 Press the belt clip downward until you hear a click.

Remove the Belt Clip

- 1 Use a flat-bladed screwdriver to press the belt clip tab away from the battery.

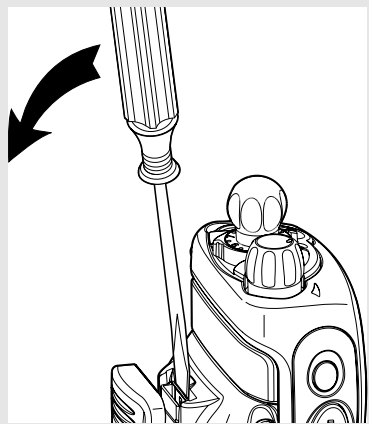

- 2 Slide the belt clip upward to remove it.

Universal Connector Cover

The universal connector cover is located on the antenna side of the radio. It is used to connect certain accessories to the radio.

Note: To prevent damage to the connector, shield it with the connector cover when not in use.

Remove the Connector Cover

- 1 Insert a flat-bladed screwdriver into the area between the bottom of the cover and the slot below the connector.
- 2 Hold the top of the cover with your thumb while you pry the bottom of the cover away from the radio with the screwdriver.

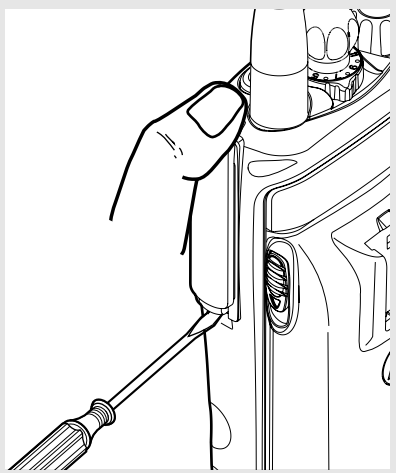

Attach the Connector Cover

- 1 Insert the hooked end of the cover into the top of the connector. Press downward on the cover's top to seat it into the slot.
- 2 Press the cover's lower tab below the connector until it snaps in place.

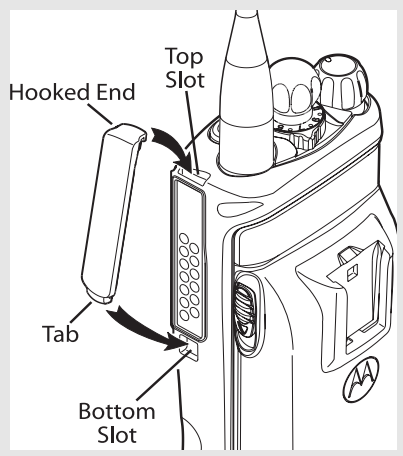

Remote Speaker Microphone Adapter

The Remote Speaker Microphone (RSM) adapter is located on the back of the radio, just above the battery. **It must be used to connect the RSM accessories (see page 116) to the radio.** If the RSM is not used, the adapter should be removed.

Remove the Adapter

Lift the larger side (below the antenna port) of the adapter away from the radio using your finger.

If you cannot easily remove the adapter with your finger, use a small, flat bladed screwdriver to pry the larger end side of the adapter away from the radio.

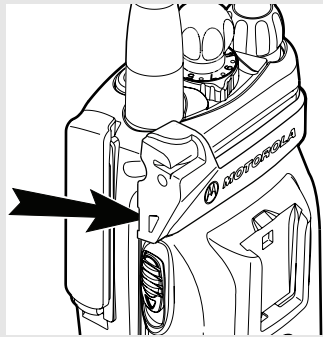

Attach the Adapter

- 1 With the Motorola side of the adapter facing out, snap the smaller end of the adapter into place in the shroud indent, below the **On/Off Volume Control Knob**.

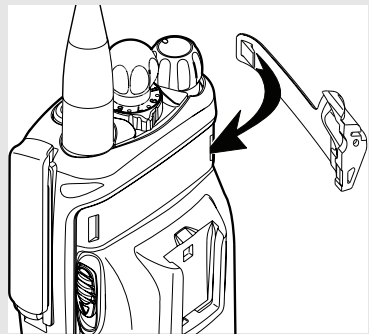

General Radio Operation

- 2 Snap the larger end of the adapter into place in the shroud indent, below the antenna port.

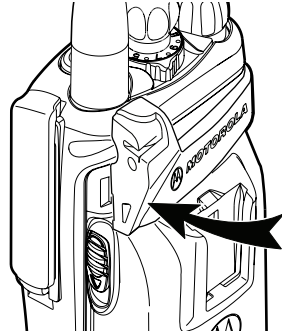

Radio On and Off

Turn the Radio On

Turn the **On/Off/Volume Control** knob clockwise.

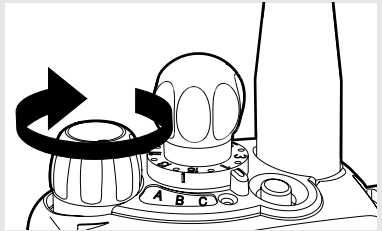

- If the power-up test is successful, you will briefly see `Self Test` and then the home display.
- If the power-up test is unsuccessful, you will see `ERROR XX/YY`. (XX/YY is an alphanumeric code.) Turn off the radio, check the battery, and turn the radio on again. If the radio continues to fail the power-up test, record the `ERROR XX/YY` code and contact a qualified service technician.

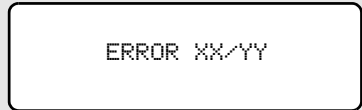
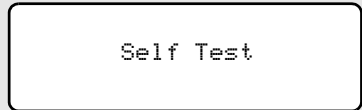

Turn the Radio Off

Turn the **On/Off/Volume Control** knob counterclockwise until it clicks.

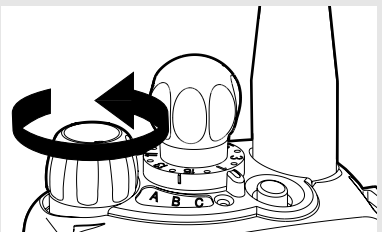

Zones and Channels

A zone is a grouping of channels. A channel is a group of radio characteristics, such as transmit/receive frequency pairs.

Before you use your radio to receive or send messages, you should select the zone and channel.



Select a Zone

Use the Menu Entry ZONE

- 1 Press  to find ZONE.



ZONE

- 2 Press , , or  directly below ZONE.
The current zone (in this case, POL) blinks and the channel name (DISP NW), does not blink.



POL DISP NW

- 3 Press  to find the zone you want. For example, FIRE.

OR

Use the **keypad** directly to dial the zone number.



FIRE DISP NW

- 4 Press  to confirm the displayed zone and channel.

OR

Press the **PTT** button to transmit on the displayed zone/channel.





FIRE DISP NW



Use the Menu Entry ZNUP or ZNDN

- 1 Press  to find ZNUP and ZNDN.



- 2 Press , , or  directly below ZNUP or ZNDN until the zone you want appears.



Note: Positions of ZNUP and ZNDN on the display may differ each time you release , , or . Read carefully before you press.

Use the Preprogrammed Zone Switch

- 1 If a control on your radio has been preprogrammed as the **Zone** Switch, move the **Zone** Switch to the position for the zone you want.

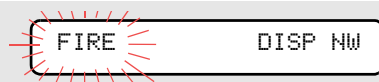

Note: If the zone you selected is unprogrammed, repeat step 1.



- 2 Press  to confirm the displayed zone and channel.

Select a Channel

Consult an authorized service technician for the right choice between the following methods.

Use the Preprogrammed Channel Selector

After the zone you want is displayed, turn the preprogrammed **Channel Selector** switch to the desired channel.





Use the Menu CHAN

- 1 Press  to find CHAN.



CHAN

- 2 Press , , or  directly below CHAN.

The display shows the current channel name (in this case, DISP NW) blinking and the zone (POL), not blinking.



POL  DISP NW

- 3 Press  to find the channel name you want.

OR

Use the keypad to enter the channel number.



POL  DISP SE

Note: If the channel you selected is unprogrammed, repeat step 3.



UNPROGRAMMED

- 4 Press  to confirm the displayed zone and channel.

OR



Press the **PTT** button to transmit on the displayed zone/channel.





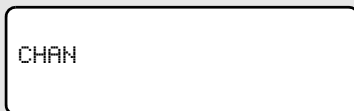

Use the Menu Entry CHUP or CHDN

- 1 Press  to find CHUP and CHDN.

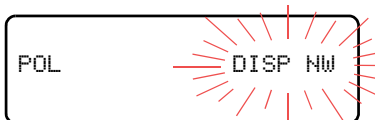

- 2 Press , , or  directly below CHUP or CHDN until the channel name you want appears.



Note: Positions of CHUP and CHDN on the display may differ each time you release , , or . Read carefully before you press.

- 3 Press the **PTT** button to transmit on the displayed zone/channel.

Mode Select Button

This feature lets you program the current zone and channel to a **Mode Select** button with a long press on the **Mode Select** button. After the buttons are programmed, you can return to the pre-programmed zone and channel with a short press on the programmed **Mode Select** button.

The buttons that are assigned for this feature are labeled in the following picture.

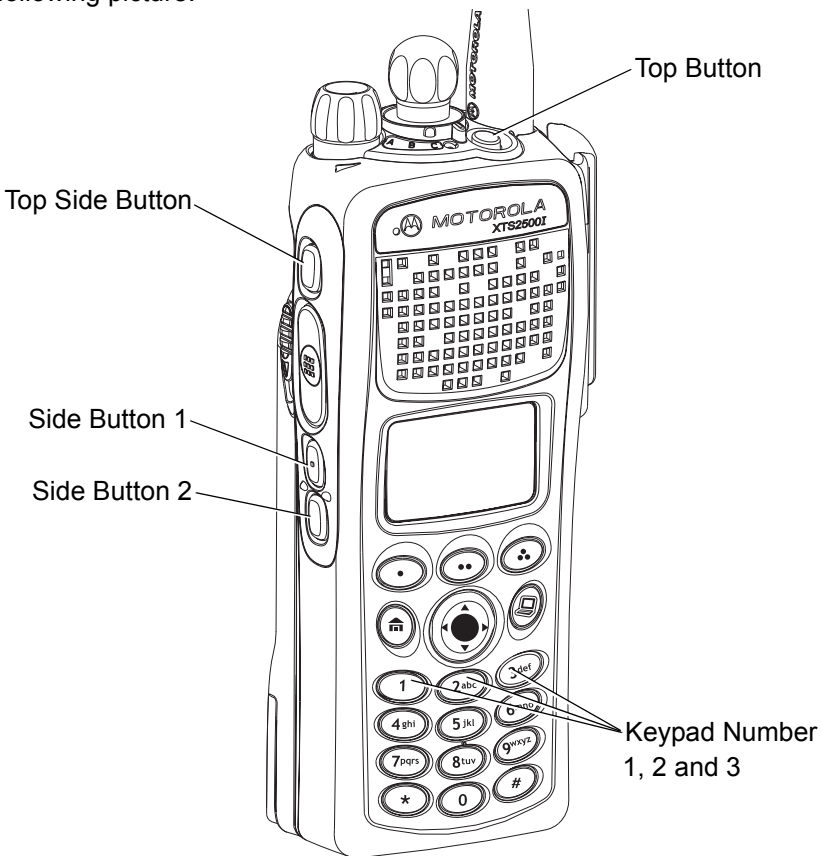

Note: ①, ②^{abc} or ③^{def} require a qualified technician to enable as the **Mode Select** buttons.

Receive / Transmit

Radio users who switch from analog to digital radios often assume that the lack of static on a digital channel is an indication that the radio is not working properly. This is not the case. Digital technology quiets the transmission by removing the noise from the signal and allowing only the clear voice or data information to be heard.

This section emphasizes the importance of knowing how to monitor a channel for traffic before keying-up to send a transmission.

Without Using the Volume Set and Monitor Buttons

- 1 Turn the radio on and select the desired zone and channel.
- 2 Listen for a transmission.
- 3 Adjust the **Volume Control** knob if necessary.

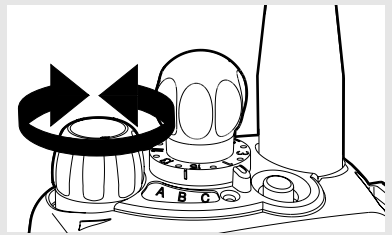

- 4 Press and hold the **PTT** button to transmit. The LED lights RED while transmitting.
- 5 Release the **PTT** button to receive (listen).

Use Preprogrammed Volume Set Button

- 1 Turn the radio on and select the desired zone and channel. See **Turn the Radio On**, page 25 and **Zones and Channels**, page 26.
- 2 Press and hold the **Volume Set** button to hear the volume set tone.
- 3 Release the **Volume Set** button.
- 4 Adjust the **Volume Control** Knob if necessary.

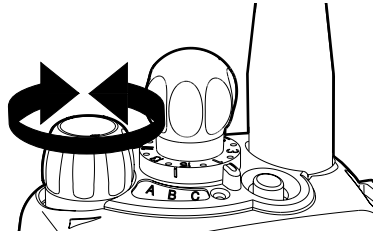

- 5 Press and hold the **PTT** button to transmit. LED lights RED while transmitting.
 - 6 Release **PTT** button to receive (listen).
-

Use the Preprogrammed Monitor Button

1 Turn the radio on and select the desired zone and channel.

2 Press the **Monitor** button and listen for activity. The Carrier Squelch indicator is displayed. (See the following **Conventional Mode Operation.**)



3 Adjust the **Volume Control** Knob if necessary.

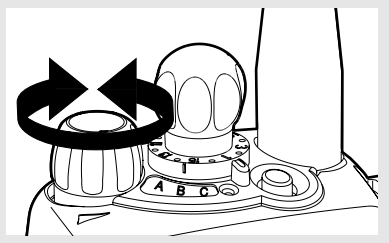

4 Press and hold the **PTT** button to transmit.

The LED lights RED while transmitting.

5 Release the **PTT** button to receive (listen).

Conventional Mode Operation

Your radio may be programmed to receive Private Line (PL) calls.

- 1 Momentarily press the **Monitor** button to listen for activity. The Carrier Squelch indicator is displayed.



- 2 Press and hold the **Monitor** button to set continuous monitor operation. (The duration of the button press is programmable.)

- 3 Press the **Monitor** button again, or the **PTT** button, to return to the original squelch setting.

Note: If you try to transmit on a receive-only channel, you will hear an invalid tone until you release the **PTT** button.

Common Radio Features

Radio Lock

This feature provides stronger radio security.

If this feature is enabled by a qualified technician, you will see RADIO LOCKED when you turn the radio on.

Unlock Your Radio

- 1 Enter your numeric password of up to 8 characters. (Use  to backspace if you make a mistake.)

- 2 Press the preprogrammed **Select** button after you enter your password. If the password is correct, the radio unlocks.

- 3 Press the preprogrammed side button to verify the password. Radio unlocks if password is correct.



Note: If the password is incorrect, the radio remains locked.

Note: DEADLOCK is displayed after three incorrect password attempts. Turn the radio off and on, and begin again at step 1.

Change Your Password

1 Press  to find PSWD.



PSWD

2 Press , , or  directly below PSWD.

OLD PASSWORD

3 Enter the old password.

SEL

4 Press , , or  directly below SEL.

NEW PASSWORD

5 Enter new password.



SEL

6 Press , , or  directly below SEL.

CONFIRM

7 Re-enter password.

SEL

8 Press , , or  directly below SEL. The password is updated.

If the two passwords do not match, repeat steps 5 through 8.

NEW PASSWORD

Note: You cannot access this feature again after three failed attempts until you turn the radio off and on.



Mute or Unmute Keypad Tones

You can turn the keypad tones off and on.

Use the Menu

- 1 Press  to find MUTE.



MUTE

- 2 Press , , or  directly below MUTE. The current state is shown.

TONES OFF
OFF ON

or

TONES ON
OFF ON

- 3 Press , , or  directly below

ON

or

OFF

Note: Press the  or the **PTT** button to exit without changing the setting.

Using the Preprogrammed Side Button

Press the preprogrammed side button to turn the tones off or on.

Conventional Squelch Options

Analog Squelch

Tone Private Line (PL), Digital Private-Line (DPL), and carrier squelch can be available (preprogrammed) per channel.

When in...	this condition occurs:
Carrier squelch ([-])	You hear all traffic on a channel.
PL, DPL	The radio responds only to your messages.

Digital Squelch

One or more of the following options may be programmed in your radio. Consult your service technician for more information.

This option...	allows you to hear:
Digital Carrier-Operated Squelch (COS)	any digital traffic.
Normal Squelch	any digital traffic having the correct Network access code.
Selective Switch	any digital traffic having the correct Network access code and correct talkgroup.

PL Defeat

With this feature, you can override any coded squelch (DPL, PL, or network ID) that might be preprogrammed to a channel.

Place the preprogrammed **PL Defeat** switch in the **PL Defeat** position. You can now hear any activity on the channel. The radio is muted if no activity is present.

When this feature is active, the Carrier Squelch status indicator (E=) will be displayed.



Time-out Timer

The time-out timer turns off your radio's transmitter. The timer is set for 60 seconds at the factory, but it can be programmed from 0 to 7.75 minutes (465 seconds) by a qualified radio technician.

- 1** Hold down the **PTT** longer than the programmed time.
 - Short warning tone
 - Transmission is cut-off
 - LED goes out

You will hear a short, low-pitched warning tone, the transmission is cut-off, and the LED will go out until you release the **PTT**.
- 2** Release the **PTT** button.
 - LED re-lights
 - Timer resets
- 3** Press the **PTT** to re-transmit. Time-out timer restarts.
 - Timer restarts
 - RED LED

Emergency

If the top (orange) button is programmed to send an emergency signal, then this signal overrides any other communications over the selected channel.

Your radio can be programmed for the following:

- Emergency Alarm
- Emergency Alarm with Emergency Call, or
- Silent Emergency Alarm
- Emergency Call.

Consult a qualified radio technician for emergency programming of your radio.

Send an Emergency Alarm

An Emergency Alarm will send a data transmission to the dispatcher, identifying the radio sending the emergency.

- 1 With your radio turned on, press the **Emergency** button. The current zone/channel is displayed alternately with **EMERGENCY**, the LED lights **RED**, and a short, medium-pitched tone sounds.



EMERGENCY

- RED LED
- Short Tone

If the selected channel does not support emergency, the display shows **NO EMERGENCY**. Select a channel that does show **EMERGENCY**.



NO EMERGENCY

Note: To exit emergency at any time, press and hold the Emergency button for about a second.

2 When you receive the dispatcher's acknowledgment, you see **ACK RECEIVED**, four tones sound, the alarm ends, and the radio exits the emergency mode.

ACK RECEIVED

- Four tones
- Alarm ends
- Radio exits emergency

If no acknowledgement is received, you see **NO ACKNOWLEDG**, the alarm ends, and the radio exits the emergency mode.

NO ACKNOWLEDG

Note: For Emergency Alarm with Emergency Call: The radio enters the Emergency Call state either after it receives the dispatcher's acknowledgment, or if you press the **PTT** button while in Emergency Alarm. Go to step 2 below: "Send an Emergency Call."

Send an Emergency Call

An Emergency Call will send a type of dispatch giving your radio priority access to channels.

The radio operates in the normal dispatch manner while in Emergency Call, except, if enabled, it will return to one of the following:

Using this operation:	means you will talk:
1. Tactical/Non-Revert	on the channel you selected before you entered the emergency state.
2. Non-Tactical/Revert	on a preprogrammed emergency channel. The emergency alarm is sent to this same channel.

- 1 With your radio turned on, press the **Emergency** button. The current zone/channel is displayed alternately with **EMERGENCY**, and a short, medium-pitched tone sounds.

EMERGENCY

- Short tone

Note: To exit emergency at any time, press and hold the **Emergency** button for about a second.

- 2 Press and hold the **PTT** button and announce the emergency into the microphone to send the Emergency call.
- 3 Release the **PTT** button to end the call.
- 4 Exit the Emergency State by pressing the **Emergency** button again for about one second (the time may be changed by a qualified technician). The radio returns to normal operation.

Send a Silent Emergency Alarm

- 1 With your radio turned on, press the **Emergency** button if your radio is programmed for this use.
 - Display does not change
 - LED does not light
 - No tones

The display does not change, the LED does not light, and no tones sound.

Note: To exit emergency at any time, press and hold the **Emergency** button for about a second.

2 The silent emergency state continues until you press and hold the **Emergency** button for about a second to exit the emergency state.

- Press and hold the **Emergency** button

OR

Press and release the **PTT** button to exit silent emergency. The silent alarm is cancelled without an exit tone, and you can begin transmitting voice calls.

OR

- Press and release the **PTT** button

Note:

- For ALL Emergency signals: You can change channels while in Emergency operation if the new channel is also programmed for Emergency. The emergency alarm or call continues on the new channel.
- If the new channel is NOT programmed for Emergency, you see **NO EMERGENCY**, and hear an invalid tone until you exit the Emergency state or change to a channel programmed for emergency.

Emergency Keep-Alive

If the radio is in the Emergency state, with Emergency Keep-Alive enabled, you cannot turn off the radio by using the **On/Off Control** knob.

With Keep-Alive, the radio will only exit the Emergency state using one of the ways mentioned in the previous sections (Emergency Alarm, Silent Emergency Alarm, or Emergency Call).

Lists

You can use lists to store frequently used numbers and associate them with names.

There are four list types:



- Call
- Page
- Phone
- Scan

View a List



1 Press  to find VIEW.



2 Press , , or  directly below VIEW.



3 Press , or  to see the names of the available lists.



4 Press , , or  directly below the desired list to view it.

The first list member is displayed. indicates the view mode.



5 Press , or  to view other list members.

6 Press  to exit.

Scan List Empty

If the scan list has no members, `EMPTY LIST` is displayed.



`EMPTY LIST`



`EMPTY LIST` can be changed by turning scan off, or if a qualified technician adds members to the scan list.

Edit a Call, Page, or Phone List Number

Use the Menu



- 1 Press  to find PROG.

PROG

- 2 Press , , or  directly below PROG.



PAGE CALL PHON

The changeable lists are displayed.



- 3 Press , , or  directly below the list you wish to change.



FIRE CHIEF 
701234
NUM NAME

First list member is displayed. Blinking  indicates programming mode.

- 4 Press  or  to select the list member to be changed.



SECURITY 
704321
NUM NAME



- 5 Press , , or  directly below NUM. Blinking cursor shows location of number to be added.

SECURITY 
70432 
SAVE

OR

You can use the keypad to enter the corresponding location number of the name in the list.

6 Press  to erase digits. If you erase the entire number and press  or , you exit the edit mode without saving your changes. Press a keypad button to add a digit.

7 Press , , or  directly below **SAVE** to save your change.

Return to step 4 to make more changes.

OR



Press  to return to home display.

Edit a Call, Page, or Phone List Name

Use the Menu



- 1 Press  to find PROG.



- 2 Press , , or  directly below PROG.



The changeable lists are displayed.







- 3 Press , , or  directly below the list you wish to change.

First list member is displayed. Blinking  indicates programming mode.

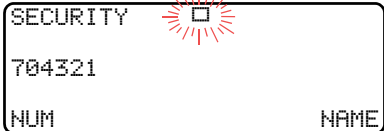

- 4 Press , or  to select the list member to be changed.





- 5 Press , , or  directly below NAME. Blinking cursor shows location of character to be added.

OR

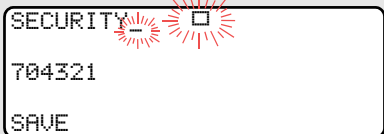

You can use the keypad to enter the corresponding location number of the name in the list.

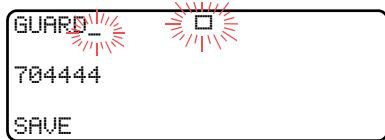

- 6 Press  to erase the last digits. (If you erase the entire name and press , you exit the edit mode without saving your changes.)



Press a keypad button to add a character. See “Keypad” on page 11.

- 7 Press , , or  directly below `SAVE` to save your change.

Return to step 4 to make more changes.

OR

Press  to return to home display.

Scan

The scan feature allows you to monitor traffic on different channels by scanning a preprogrammed list of channels. Your radio can have up to 20 different scan lists. These lists must be preprogrammed by a qualified technician.

You can view the scan list assigned to the currently selected channel the same way you would view other lists. See “View a List” on page 45.

Turn Scan On and Off

Using the Menu





- 1 Press  to find SCAN.

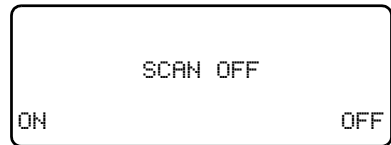

- 2 Press , , or  directly below SCAN.

The current scan state is displayed.



- 3 Press , , or  directly below ON or OFF. When scan is on, the scan status symbol () is displayed.

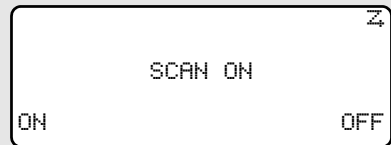

OR

To exit the display menu without changing the scan state, press  or **PTT**.

Use the Preprogrammed Scan On/Off Switch

Place the **Scan On/Off** switch in the Scan On or Scan Off position.

The current scan state is displayed. When scan is on, the scan status symbol (Z) is displayed.



Note: To exit the display menu without changing the scan state, press  or **PTT**.

Delete a Nuisance Channel

When the radio scans to a channel that you do not wish to hear (nuisance channel), you can temporarily delete the channel from the scan list.

- 1** When the radio is locked onto the channel to be deleted, press the preprogrammed **Nuisance Delete** button.

Repeat this step to delete more channels.

Note: You cannot delete priority channels or the designated transmit channel.

- 2** The radio continues scanning the remaining channels in the list. To resume scanning the deleted channel, change channels or turn scan off and then back on again.
-

Conventional Scan Only

Make a Dynamic Priority Change

While the radio is scanning, the dynamic priority change feature lets you *temporarily* change any channel in a scan list (except the priority-one channel) to the priority-two channel. The replaced priority-two channel becomes a non-priority channel. This change remains in effect until scan is turned off, then scanning reverts back to the preprogrammed state.

- 1 When the radio is locked onto the channel to be designated as priority-two, press the preprogrammed **Dynamic Priority** button.

Note: The priority-one channel cannot be changed to priority-two.

- 2 The radio continues scanning the remaining channels in the list. To resume scanning the preprogrammed priority-two channel, you must leave and re-enter scan operation.
-

Telephone Calls (Trunking Only)

Use your radio to make and receive standard phone calls. A landline phone can be used to call a radio, or a radio can be used to call a landline phone.

Answer a Phone Call

Use the Preprogrammed Call Response Button

- 1 When a phone call is received, you hear a telephone-type ringing, the LED blinks GREEN, the call-received symbol (☎) blinks, and PHONE CALL is displayed.

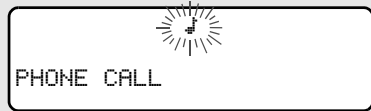

- Telephone ringing
- Blinking GREEN LED

- 2 Press the **Call Response** button within 20 seconds after the call indicators begin.

- 3 Press and hold the **PTT** button to talk; release it to listen.



- 4 Press (Ⓜ) to hang up and return to the home display.
-

Make a Phone Call

Use the Menu

- 1 Press  to find PHON.

PHON





- 2 Press , , or  directly below PHON.

The last phone number is dialed is displayed.

55501234

LIST

- Note:** If you wish to call this number, go to Step 4. Otherwise, continue to Step 3.

- 3 Press  or  to scroll to the phone number you want in the list. Press , , or  directly under LNUM to go to the last phone number dialed.

POLICE

55508523

LNUM

- 4 Press the **PTT** button to start the phone call to the displayed number.

OR

Press the preprogrammed **Quick Access** button to start the phone call to the displayed number.

- 5 Press and hold the **PTT** button to talk, release it to listen.

OR

If your call is not answered, go to “Phone Call Display and alert Prompts” on page 58.

- 6 Press  to hang up and return to the home display.

Use the Keypad

- 1 Press  to find PHON.

PHON

- 2 Press , , or  directly below PHON.

55501234

LIST

You see the last transmitted or received ID number.

- 3 Enter the phone number you want using the keypad.

55508523

LIST

- 4 Press the **PTT** button to start the phone call to the displayed number.

OR

Press the preprogrammed **Quick Access** button to start the phone call to the displayed number.







- 5 Press and hold the **PTT** button to talk, release it to listen.

OR

If your call is not answered, go to “Phone Call Display and alert Prompts” on page 58.

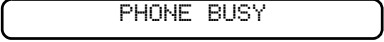
- 6 Press  to hang up and return to the home display.

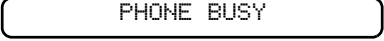
Phone Call Display and Alert Prompts

<ul style="list-style-type: none"> When you press the PTT button and the phone system is not available, a long tone sounds. Press  button, to hang up. Radio returns to the home display. 	
<ul style="list-style-type: none"> When a channel is not available, a busy tone sounds. The radio will automatically connect when a channel opens. 	
<ul style="list-style-type: none"> When the phone system is busy, a long tone sounds. Try your call later. Press  button, to hang up. Radio returns to the home display. 	
<ul style="list-style-type: none"> The system does not acknowledge your call. Press  button, to hang up. Radio returns to the home display. 	

Notes: • A high-pitched tone, generated when you release the **PTT** button, indicates to the landline party that he or she can begin talking.

- You have the option of sending additional digits (overdial), such as an extension number, or credit card or PIN numbers, to the phone system. If the radio is programmed for live overdial, every digit entered after the call is connected is sent to the phone system.
- If the radio is programmed for buffered overdial, the digits pressed are entered into memory and then sent when the **PTT** button is pressed. Press the **PTT** to send either digits or voice, but not both at the same time.

Private Calls (Trunking Only)

These one-to-one calls between two radios are not heard by others in the current talkgroup. The calling radio automatically verifies the receiving radio is active on the system and can display the caller's ID.

Answer a Private Call

Use the Preprogrammed Call Response Button.

- 1 When a private call is received, you hear two alert tones, the LED blinks GREEN, the call-received symbol (📞) blinks, and CALL RECEIVED is displayed.



- Two tones
- Blinking GREEN LED

- 2 Press the **Call Response** button within 20 seconds.

If the caller's name is in the call list, it will be displayed.

OR

If the name is not in the call list, the caller's ID number is displayed.

- 3 Press and hold the **PTT** button to talk; release it to listen.

- 4 Press  or the **Call Response** button to hang up.

Make a Private Call

Use the Menu



- 1 Press  to find CALL.

CALL

- 2 Press , , or  directly below CALL.

FIRE CHIEF
ID: 701234
LIST

You see the last transmitted or received ID number

- 3 Press  or  to scroll to the ID number you want in the list.

FIRE CHIEF
ID: 701234
LNUM

Note: Press LNUM to go to the last number dialed.

- 4 Press the **PTT** button to start the Private Call to the displayed number.

OR

Press the preprogrammed **Quick Access** button to start the private call to the displayed number.

- 5 The called ID is momentarily displayed, followed by PLEASE WAIT. The called ID is displayed once connected.

PLEASE WAIT

If the system does not acknowledge the call, NO ACKNOWLEDG is displayed.

NO ACKNOWLEDG



If the target radio does not respond before the time out, NO ANSWER is displayed.

NO ANSWER

Use the Keypad

- 1 Press  to find CALL.

CALL

- 2 Press , , or  directly below CALL.

You see the last transmitted or received ID number.

FIRE CHIEF
ID: 701234
LIST

- 3 Use the keypad to enter the ID number you want to call.

FIRE CHIEF
ID: 701234
LIST

OR

Press the **PTT** button to start the Private Call to the displayed number.

OR

Press the preprogrammed **Quick Access** button to start the phone call to the displayed number.

- 4 The called ID is momentarily displayed, followed by PLEASE WAIT. The called ID is displayed once connected.

PLEASE WAIT

If the system does not acknowledge the call, NO ACKNOWLEDG is displayed.

NO ACKNOWLEDG

If the target radio does not respond before the time out, NO ANSWER is displayed.

NO ANSWER

Call Alert Paging

Call Alert allows your radio to work like a pager. Even if other users are away from their radios, or if they are unable to hear their radios, you can still send them a Call Alert page. You can also verify if a radio is active on the system.

Answer a Call Alert Page

- 1 When a Call Alert Page is received, you hear four repeating alert tones, the LED blinks GREEN, the call-received symbol (📞) blinks, and PAGE RECEIVED is displayed.



- Four repeating alert tones
- Blinking GREEN LED



- 2 Press and hold the **PTT** button to talk, release it to listen.
-

Make a Call Alert

Use the Menu

- 1 Press  to find PAGE.

PAGE

- 2 Press , , or  directly below PAGE.

You see the last transmitted or received ID number.

FIRE CHIEF
ID: 701234
LIST

- 3 Use the keypad to enter the ID number you want to call.

Note: Press LNUM to go to the last number dialed.

FIRE CHIEF
ID: 701234
LNUM

- 4 Press the **PTT** button to start the Call Alert Page to the displayed number.

OR

Press the preprogrammed **Quick Access** button to start the page to the displayed number.

PLEASE WAIT is displayed. The home display appears once you are connected.

PLEASE WAIT



If the system does not acknowledge the call, NO ACKNOWLEDG is displayed.

NO ACKNOWLEDG

Use the Keypad

- 1 Press  to find PAGE.

PAGE

- 2 Press , , or  directly below PAGE.

You see the last transmitted or received ID number.

FIRE CHIEF
ID: 701234
LIST

- 3 Enter the ID number you want using the keypad.

FIRE CHIEF
ID: 701234
LIST

- 4 Press the **PTT** button to start the Call Alert Page to the displayed number.

OR

Press the preprogrammed **Quick Access** button to start the page to the displayed number.

PLEASE WAIT is displayed. The home display appears once you are connected.

PLEASE WAIT

If the system does not acknowledge the call, NO ACKNOWLEDG is displayed.

NO ACKNOWLEDG



Conventional Talkgroup Calls (Conventional Operation Only)

Talkgroup Call lets you define a group of conventional system users so that they can share the use of a conventional channel.



Select Talkgroup

- 1 Press  to find TGRP.





- 2 Press , , or  directly below TGRP.

The last user-selected-and-stored talkgroup, and its available softkeys, are displayed.

- 3 Press  or  to find the talkgroup you want.

OR

Use the keypad to enter the number of the desired corresponding talkgroup in the list.

- 4 Press , , or  directly below PSET (to select the preset or programmed talkgroup), or below SEL (to save the talkgroup and return to the home display).



- 5 To exit, press  or the **PTT** button, or turn the **16-Position Select** knob.

Repeater or Direct Operation

Also known as TALKAROUND operation, DIRECT lets you bypass the repeater and connect directly to another radio. The transmit and receive frequencies are the same.



REPEATER operation increases the radio's range by connecting with other radios through a repeater. Transmit and receive frequencies are different.

Select Repeater or Direct Operation





Use the Menu

- 1 Press  to find DIR.

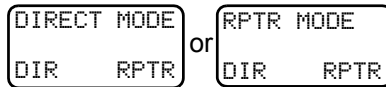

- 2 Press , , or  directly below DIR. The current operation is momentarily displayed.



- 3 Press , , or  directly below DIR or RPTR.
If DIR is selected, the display shows  and DIRECT MODE.

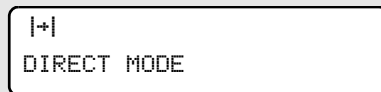

- 4 Press  to exit display menu without changing the current operation.
-

Special Radio Features

Radio Kill

This feature allows you to render your radio or another radio inoperable if the radio is misplaced or lost. When a radio is killed, the display blanks and all functions of the radio will not be usable.

Note: Radio can only be recovered from KILL with a special device. Contact your Authorized Service Personnel.

There are two ways to initiate the Radio Kill feature:

Remote Kill

Remote Kill allows you to render another radio inoperable by sending an over the air command using the menu.

- 1 Press  to find KILL.

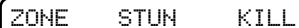

- 2 Press , , or  directly below KILL.



Enter your Tactical Inhibit
Encode Password.

- 3 Press Button 1 to proceed

- 4 Enter the targeted Radio ID manually or select from call list.

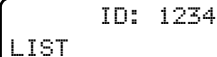

- 5 Press  directly below SEND to initiate command..

Direct Kill

Direct Kill allows you to make your own radio inoperable.



- 1 Press and hold Button 1 then press the Orange button until the display blanks.

Radio Stun

This feature allows you to stun another radio by sending an over the air command using the menu. When a radio is stunned, it will be locked to prevent any unauthorized usage of the radio. A password is required to re-activate the stunned radio.

- 1 Press  to find STUN.

ZONE STUN KILL

- 2 Press , , or  directly below STUN.

ENTER PSWD:

Enter your Tactical Inhibit
Encode Password.

- 3 Press Button 1 to proceed.

- 4 Enter the targeted Radio ID manually or select from call list.

ID: 1234
LIST

- 5 Press  directly below SEND to initiate command.

Note: To un-stun a radio, follow the “Unlock Your Radio” on page 35.

PTT ID

Receive



This feature allows you to see the radio ID number of the radio you are currently receiving. This ID can be a maximum of eight characters and can be viewed by both the receiving radio and the dispatcher.

Transmit

Your radio's ID number is automatically sent every time the **PTT** button is pressed. This is a per-channel feature. For digital voice transmissions, your radio's ID is sent continuously during the voice message.

View Your Radio's ID Number



Use the Menu

- 1 Press  or  to find CALL or PAGE.

CALL

or

PAGE

- 2 Press , , or  directly below CALL or PAGE.

- 3 Press .

MY ID:
701111

Use the Preprogrammed Call or Page Button

- 1 Press the **Call** or **Page** button.

- 2 Press .

MY ID:
701111

Dynamic Regrouping (Trunking Only)

The dynamic regrouping feature lets the dispatcher temporarily reassign selected radios to a single special channel so they can communicate with each other. This feature is typically used during special operations and is enabled by a qualified radio technician. You will not notice whether your radio has this feature enabled until a dynamic regrouping command is sent by the dispatcher.

Note: If you try to access a zone or channel that has been reserved by the dispatcher as a dynamically regrouped mode for other users, you will hear an invalid tone.

When your radio is dynamically regrouped, it automatically switches to the dynamically regrouped channel. You see the dynamically regrouped channel's name, and hear a "gurgle" tone.

Press the **PTT** button to talk; release it to listen.

When the dispatcher cancels dynamic regrouping, the radio automatically returns to the zone and channel that you were using before the radio was dynamically regrouped.



Reprogram Request (ASTRO 25 Trunking Only)

This feature lets you notify the dispatcher that you want a new dynamic regrouping assignment.

Use the Menu

1 Press  to find RPGM.

RPGM

2 Press , , or  directly below RFGM.

REPRGRM ROST

The reprogram request is sent to the dispatcher.

3 If you hear *one beep*

- Press the **PTT** button to send the reprogram request again.

OR

- Press  to cancel and return to the home display.

OR

If you hear *five beeps*, the reprogram request was acknowledged by the dispatcher. Your radio returns to the home display.

OR

If the dispatcher does not acknowledge the reprogram request within six seconds, you see **NO ACKNOWLEDG** and hear a low-pitched alert tone.



NO ACKNOWLEDG

- An alert tone

Try again or press .

Use the Preprogrammed Reprogram Request Button

- 1** Press the **Reprogram Request** button. You see **REPRGRM RQST**.



REPRGRM RQST

The reprogram request is sent to the dispatcher.

- 2** If you hear *one beep*
- One beep
 - Press the **PTT** button to send the reprogram request again

OR

- Press  to hang up and return to the home display.

OR

- If you hear *five beeps*, the reprogram request was acknowledged by the dispatcher. Your radio returns to the home display.
- Five beeps

OR

If the dispatcher does not acknowledge the reprogram request within six seconds, you see `NO ACKNOWLEDG` and hear a low-pitched alert tone.



- An alert tone

Try again or press .

Select Enable / Disable

The dispatcher can classify regrouped radios into either of two categories: Select Enabled or Select Disabled.

- Select-enabled radios are free to change to any available channel, including the dynamic-regrouping channel, once the user has selected the dynamic-regrouping position.
- Select-disabled radios cannot change channels while dynamically regrouped. The dispatcher has forced the radio to remain on the dynamic-regrouping channel.

The Scan or Private Call feature cannot be selected while your radio is Select Disabled.

Trunking System Controls

Failsoft

The failsoft system ensures continuous radio communications during a trunked system failure. If a trunking system fails completely, the radio goes into failsoft operation and automatically switches to its failsoft channel.

During failsoft operation:

Your radio transmits and receives in conventional operation on a predetermined frequency.



FAILSOFT

You hear a medium-pitched tone every 10 seconds.

- Medium-pitched tone

When the trunking system returns to normal operation, your radio automatically leaves failsoft operation and returns to trunked operation.

Out-of-Range

If you go out of the range of the system, and can no longer lock onto a control channel:

The display shows **OUT OF RANGE** and the currently selected zone/channel combination, and/ or you hear a low-pitched tone.



OUT OF RANGE

AND/OR

Your radio remains in this out-of-range condition until it locks onto a control channel, or it locks onto a failsoft channel, or it is turned off.

- Low-pitched tone
- Locks onto a control channel, or
- Locks onto a failsoft channel, or
- Turned off.

Site Lock

This feature allows your radio to lock onto a specific site and not roam among wide-area talkgroup sites. This feature should be used with caution, since it inhibits roaming to another site in a wide-area system.

Lock or Unlock a Site

Use the Menu

- 1 Press or to find SITE.

SITE

- 2 Press , , or directly below SITE.

The current lock state is displayed.

SITE UNLOCKED
LOCK UNLK

SITE LOCKED
LOCK UNLK

- 3 Press , , or directly below LOCK or UNLK.

- The new site-lock state is saved.
- Your radio returns to the home display.

Use the Preprogrammed Site Lock/Unlock Button

- 1 Press the **Site Lock/Unlock** button.

The current lock state is momentarily displayed.

SITE LOCKED

OR

SITE UNLOCKED

- 2 Press and hold the **Site Lock/Unlock** button until you see the desired lock state.

SITE LOCKED

OR

SITE UNLOCKED

Site Trunking

If the zone controller loses communication with any site, that site reverts to what is known as “site trunking.” The display shows “SITE TRUNKING” and the currently selected zone/channel combination. When this occurs, you can communicate only with other radios within your trunking site.

Site View and Change

You can view the ID number of the current site or force your radio to change to a new one.

View the Current Site

Momentarily press the preprogrammed **Site Search** button.

The display shows the name of the current site and its corresponding Received Signal Strength Indicator (RSSI) symbol (📶)



OR

If the radio is scanning for a new site, the display momentarily shows SCANNING SITE.

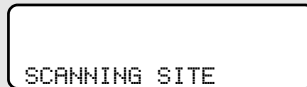

Change the Current Site

Press and hold down the preprogrammed **Site Search** button to manually force the change to a new site.

You hear a tone, and the display shows SCANNING SITE while the radio scans for a new site.

- Tone



The radio returns to the home display when it finds a new site.

Time and Date

Using this special feature, you may program the time and date as you might with other electronic devices. The clock display is enabled by a qualified radio technician.

- The default time setting is a 12-hour clock.
- If a 24-hour clock is selected, AM/PM selection is not available.
- The default setting for the domestic date shows MDY.



12HR 00:00AM

MDY 00/00/00



Edit Time and Date

- 1 Press  to find CLCK.



CLCK

- 2 Press , , or  directly below CLCK. The current setting is displayed.

12HR 03:54AM
MDY 03/07/01
EDIT

- 3 Press , , or  directly below EDIT. The first item blinks.

12HR 03:54AM
MDY 03/07/01
SAVE

- 4 Press  or  to change the selected item.

24HR 03:54
MDY 03/07/01
SAVE



Note: Press  at any time to return to the home display without saving your changes.

OR

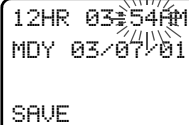
Press  one or more times to move to an item you wish to change.



12HR 03:54AM
MDY 03/07/01
SAVE

5 Press  or  to change the selected item.

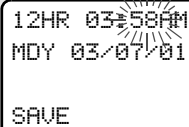

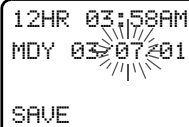

12HR 03:58AM
MDY 03/07/01
SAVE

6 Press  one or more times to move to an item in the date field.



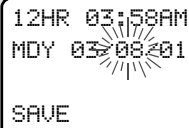

12HR 03:58AM
MDY 03/07/01
SAVE

7 Press  or  to change the selected item.



12HR 03:58AM
MDY 03/08/01
SAVE

8 When you have made all your changes, press , , or  directly below SAVE to save your changes and return to the Home display.

Note: If a call arrives while the radio is in the clock-setting menu, the radio exits clock setting, your changes are lost, and the call information is displayed.

Outdoor Location (using GPS)

The Outdoor Location (using GPS) feature allows radio users to determine their current location using a location menu. Radio location may be requested and reported over-the-air.

This feature is only available when a location enabled accessory such as the GPS Remote Speaker Microphone (RSM) is attached to the radio.



Access the Location feature

Use the Menu

- 1 Press  to find LOC.



LOC

- 2 Press , , or  directly below LOC.

If radio has just been switched on, or no location signal is available (blinking icon), the display shows the latitude and longitude of the last successful location fix. The top line will display PREVIOUS LOC.

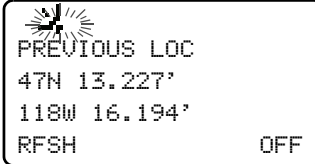



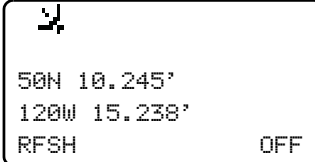

PREVIOUS LOC
47N 13.227'
118W 16.194'
RFSH OFF

As soon as a location signal is detected (solid icon), the display will be updated with the new location coordinates.

The location coordinates will be updated automatically every four minutes while the location signal is present.





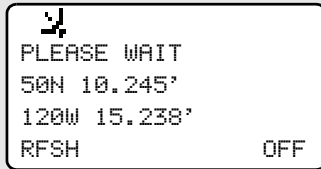

50N 10.245'
120W 15.238'
RFSH OFF

- 3 Press , , or  directly below RFSH to obtain a new location fix. The top line will temporarily display PLEASE WAIT while the new location is being determined.





 PLEASE WAIT
 50N 10.245'
 120W 15.238'
 RFSH OFF

Note: While the new location is being determined, the location signal can be solid or blinking icon.

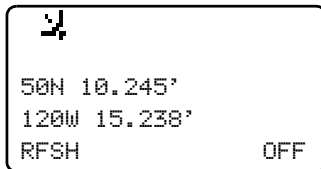
- 4 Press , , or  directly below OFF to disable the location feature to save battery power.





 50N 10.245'
 120W 15.238'
 RFSH OFF

OR

Press , , or  directly below ON to enable the location feature.

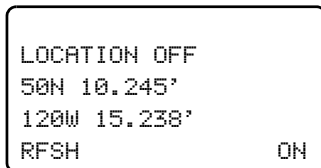
Note: An ON/OFF menu key may be present on the location menu if it is programmed by the service technician.



LOCATION OFF
 50N 10.245'
 120W 15.238'
 RFSH ON

Press  or the **PTT** button to exit this menu.

If the emergency button is pressed or the GPS RSM is disconnected, radio will also exit this menu.

Location and Emergency Feature Interaction

When the Emergency feature is activated by pressing the emergency button, the radio will exit the Location menu and return to the home (default) display so that you can see which channel the emergency signal is going out on. However, you may re-enter the Location menu while still in emergency mode, provided that Silent Emergency has not been activated.

If you have turned Location off using the ON/OFF menu key, it will be automatically turned back on when Emergency is activated.

GPS Enabled

Your RSM's GPS Enabled feature uses information from the Global Positioning System (GPS) satellites orbiting the Earth to determine the approximate geographical location of your RSM, expressed as latitude and longitude. The availability and accuracy of this location information (and the amount of time that it takes to calculate it) will vary depending on the environment in which you are using the GPS feature.

For example, GPS location fixes are very difficult to obtain indoors, in covered locations, between high buildings, or in situations where you have not established a clear broad view of the sky.

IMPORTANT: Things to Keep in Mind

The GPS technology uses radio signals from earth orbiting satellites, to establish the location co-ordinates, maximizing your view of clear unobstructed sky is essential for optimum performance. Where adequate signals from multiple satellites are not available (usually because you cannot establish a view of a wide area of the sky), the GPS feature of your RSM will not work. Such situations include but are not limited to:

- In underground locations.
- Inside of buildings, trains, or other covered vehicles.
- Under any other metal or concrete roof or structure.
- Between tall buildings or under dense tree-cover.

- In temperature extremes outside the operating limits of your RSM. Even where location information can be calculated in such situations, it may take longer to do so, and your location estimate may not be as accurate. Therefore, in any emergency situation, always report your location to your dispatcher.

Furthermore, please note that even where adequate signals from multiple satellites are available, your GPS feature will only provide an approximate location, often within 20-100 meters from your actual location, but sometimes much further from the actual location.

Keep in mind that the accuracy of the location information and the time it takes to obtain it varies depending upon circumstances, particularly the ability to receive signals from an adequate number of satellites.

The satellites used by the GPS feature are controlled by the U.S. government and are subject to changes implemented in accordance with the Department of Defense GPS user policy and the Federal Radio Navigation Plan. These changes may affect the performance of the GPS feature on your RSM.

Enhancing GPS Performance

Sometimes, the GPS feature of your RSM may be unable to complete a location calculation successfully. You will then see a message indicating that your RSM cannot see enough visible satellites.

To maximize the ability of your RSM to determine a fix, please note the following guidelines:

- Stay in the open. The GPS feature works best where there is nothing between your RSM and a large amount of open sky.
- Wear your RSM outside all clothing. Keep it as high on your body as possible, ideally at shoulder level.

Notes

ARS User Login and Text Messaging Features

Automatic Registration Service (ARS)

The Automatic Registration Service feature provides an automated data application registration for the radio. When you turn on the radio, the device automatically registers with the server. Data applications within the fixed network can determine the presence of a device on the system and send data to the device. For example: Text Messaging Service (TMS).

The Automatic Registration Service for the radio consists of 2 modes:

- ARS Server Mode (default mode)
- ARS Non Server Mode

Note: The default ARS mode can be changed by a qualified radio technician using the radio's programming software.

Selecting or Changing ARS Mode

Consult a qualified radio technician for the right choice between the following methods:

Method 1: Use the Preprogrammed 16-Position Select Knob

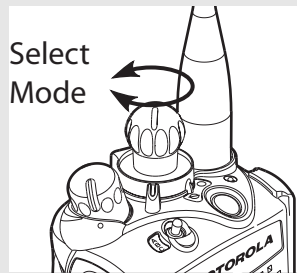

After the zone you want is displayed, turn the **16-Position Select** knob to the desired mode.



Method 2: Use the Menu

- 1 Press  to find CHAN.

CHAN

- 2 Press , , or  directly below CHAN.

The display shows the current channel name (in this case, NONSUR) blinking and the zone (Z1), not blinking.

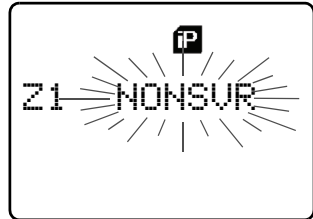

- 3 Press  to find the channel / mode you want.

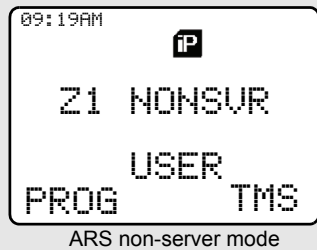
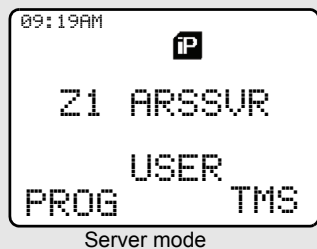

Note: If the channel/mode you selected is unprogrammed, repeat step 3.





- 4 Press  to confirm the displayed zone and channel.
-

ARS User Login Feature

The user login feature allows you as the user to be associated with the radio. With this association, every data application (Example: Text Messaging Service) will take on a friendly username. You can still send text messages without logging in as a user. The user login feature only enables the recipient of your message to identify you as the sender by assigning a username to your message.

Accessing the User Login Feature

The user login feature can be accessed by selecting a menu item on the display or through a programmable button.

- 1 Press  until **USER** appears on the display.
- 2 To access the user login screen through the menu item, press  below **USER**.

To access the user login screen through a preprogrammed button, press the preprogrammed user button.

Note: Radio buttons that are “preprogrammed” mean that a qualified radio technician must use the radio’s programming software to assign a feature to a button. Any programmable buttons on the radio can be programmed to access the user login feature. See “Programmable Features” on page 4.

- 3 The user login screen appears.

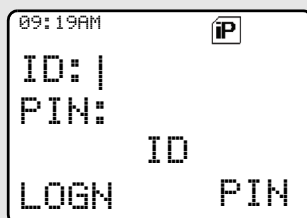

To Login as a User

- 1 Press  below ID to enter your username at the prompt.

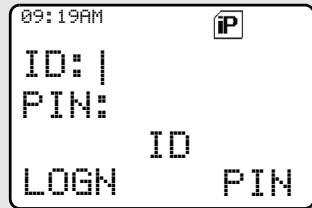













- 2 You can enter a username via direct entry using the keypad multi-tap function.

Press the key labeled with the desired character, once for the first character, twice for the second, and so on.

For example:

To enter "S", press  key four times. To enter "7", press the key five times. If you do not press a key for a few seconds, the character is accepted, and the cursor moves to the next position.

Key	Number of times the key is pressed								
	1	2	3	4	5	6	7	8	9
	0								
	1	-	*	#	/				
	A	B	C	2	a	b	c		
	D	E	F	3	d	e	f		
	G	H	I	4	g	h	i		
	J	K	L	5	j	k	l		
	M	N	O	6	m	n	o		
	P	Q	R	S	7	p	q	r	s
	T	U	V	8	t	u	v		
	W	X	Y	Z	9	w	x	y	z
	Space								
	Delete a character								

OR

Select a predefined username from the list of predefined username. See “Selecting a Predefined Username” on page 92 for information on how to add a predefined username.

Note: Valid characters for a username entry are capital letters A-Z, small letters a-z, numbers 0-9, ‘*’, ‘#’, ‘-’, ‘,’ and the space character. The maximum length for a username is 8 characters. Username will not be case sensitive in server mode and will be case sensitive in non-server mode.

- 3 Press  below PIN to enter your PIN (Personal Identification Number) number at the prompt. The maximum PIN length is 4 digits. The PIN number will appear as asterisks.

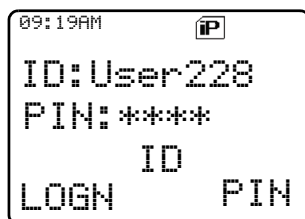

4 To log in:

Press  below LOGN.

In ARS server mode:

The progress screen appears.

In ARS non-server mode:

The logged in confirmation screen appears.

In non-ARS enabled mode:

The display shows OFFLINE.

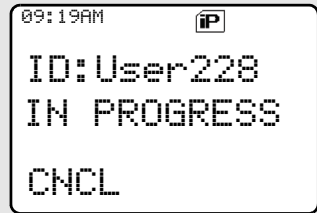

Server mode

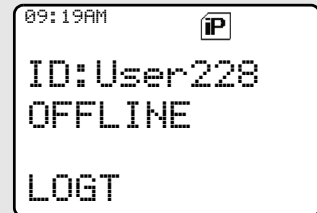

Non ARS enabled mode

- 5** Press  below CNCL to cancel the login in progress screen and return to the initial user login screen.

- 6** The logged in confirmation screen appears when the login process is successful. The "successful user login" indicator (IP indicator) will be shown on the display.

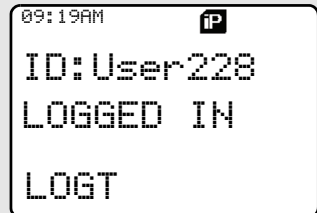

- 7** When you enter an invalid username or PIN, login fails and the user login screen will display a momentary text LOGIN FAILED. The "user login failure" indicator (blinking IP indicator) is shown on the display.

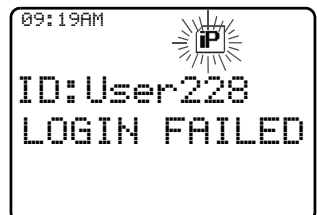

8 To log out:

Press below LOGT

Upon pressing the LOGT button, a confirmation screen appears.

Press below YES to clear all your private data. A momentary text PRIVATE DATA CLEARED is shown.

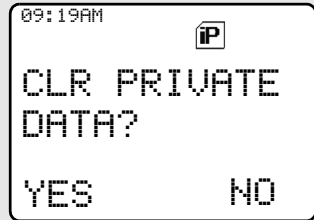

OR

Press below NO to keep your private data.

Note: Private data refers to all messages in the text messaging inbox, Draft and Sent folder. The next user will be able to access the Inbox, Draft and Sent messages if private data is not deleted.

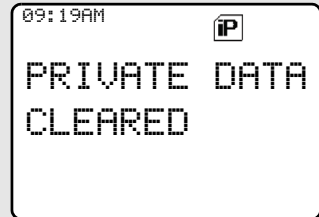

Selecting a Predefined Username

- 1 Press  to scroll to the next username.

OR

Press  to scroll to the previous username.

Press and hold , to scroll to the next usernames continuously one at a time at a fast scroll rate.

OR

Press and hold , to scroll to the previous usernames continuously one at a time at a fast scroll rate.

- 2 If you log in with a selected predefined username comprising of 8 characters or more, or one with an invalid character, you will see a momentary text INVALID ID on the display.

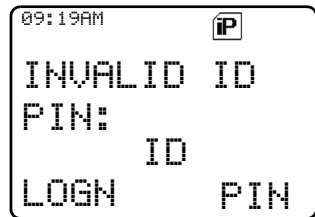

Note: A predefined username may sometimes be invalid because the programming software that is used to set predefined usernames allows you to set usernames comprising of 8 characters or more.



Text Messaging

The Text Messaging Service (TMS) is an application service through which you can send and receive text messages. You can send 3 types of text messages, namely

- A new text message (free form messages)
- Predefined messages (quick text messages)
- Edited quick text messages

Accessing TMS Feature

Use the Menu

- 1 a) Press  until TMS appears on the display.
b) Press  directly below TMS.

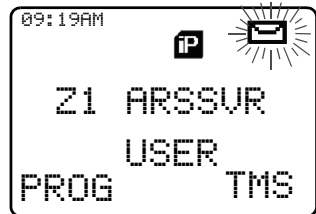

Use the TMS Feature Button

- 1 Press  to access the TMS feature screen.

Use the Preprogrammed TMS Button

- 1** Press the preprogrammed button to access the TMS feature screen.



Pressing and holding the preprogrammed button for TMS brings you directly to the Inbox screen.

Note: Any programmable button on the radio can be programmed to access TMS feature.

See “Programmable Features” on page 4 for more information on buttons that are programmable to access TMS.

- 2** The TMS feature’s main menu consists of the Inbox, Compose, Draft, Sent and Back option.

See “Table 7: TMS Menu Options” on page 95 for explanation on each menu option.

Press  or  to scroll through the main menu options.



User228
00000034





INBX COMP DRFT







Table 7: TMS Menu Options

Menu Options	Description/Function
INEX	This is used to store new incoming messages or messages that you have received. The Inbox can hold up to 30 messages.
COMP	This menu option brings you to the compose screen.
DRFT	This is used to store all saved messages or messages that are to be sent at a later time. The Draft folder can hold up to 10 messages.
SENT	This is used to store the messages that you have already sent. The Sent folder can hold up to 10 messages.
BACK	This menu option brings you back to the TMS main menu or previous menu.
EDIT	This menu option brings you to the Quick Text Messages screen.
SAVE	This menu option allows you to save your messages to the Draft folder.
RPLY	This menu option allows you to reply to a message.
DEL	This menu option allows you to delete a message.
ADDR	This menu option allows you to key in the target address, or select one from the list.
NEW	This menu option allows you to compose a new message.
LIST	This menu option allows you to select a predefined message.
IMPT	This menu option is used to toggle on/off the "Priority" flag for an outgoing message.

Menu Options	Description/Function
RGRP	This menu option is used to toggle on/off the “Request Reply” flag for an outgoing message.
CURR	This menu option is used to delete the current selected message.
ALL	This menu option is used to delete all the messages in the current message folder.

Table 8: TMS Status Symbols

Symbol	Indication
	<p>Priority Message This icon is displayed</p> <ul style="list-style-type: none"> • when “Priority” is toggled on before sending the message. • in the Inbox folder for messages which are flagged with “Priority”.
	<p>Request Reply This icon is displayed</p> <ul style="list-style-type: none"> • when “Request Reply” is toggled on before sending the message. • in the Inbox folder for messages which are flagged with “Request Reply”.
	<p>Inbox Full This icon is displayed when the Inbox folder is full.</p>
	<p>New Message Icon This icon is displayed when a new incoming message is received.</p>

<i>Symbol</i>	<i>Indication</i>
	Message Sent This icon indicates that the selected message has been successfully sent.
	Message Unsent This icon indicates that the selected message was not successfully sent.
	Read Message This icon is used to indicate that the selected message in the Inbox has been read.
	Unread Message This icon indicates that the selected message in the Inbox folder has not been read.
Inbox 3/6	Message Index This icon indicates the index of the current message the user is viewing. Example: if the user is looking at the third message out of a total of 6 messages in the Inbox folder, the icon is displayed as the icon on the left column.
	Num Lock This icon indicates that the text entry is currently in num lock mode.
	Normal Mode This icon indicates that the text entry is currently in the normal mode.
	Uppercase This icon is displayed during text editing mode to indicate that the text entry is currently in uppercase mode.

Receive a Message

When you receive a message, a momentary text, NEW MSG appears on the display along with a new message icon.

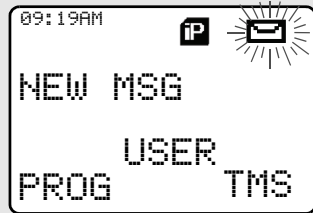

To View Message from the Inbox.

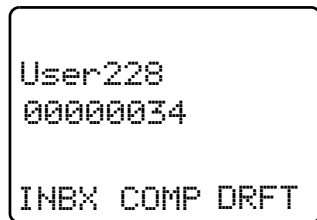

- 1 Access TMS (Launch TMS).
- 2 Press  directly below INBX.



- 3 The Inbox screen appears. The first message in the list is displayed. Inbox can hold up to 30 messages. Message status icons are displayed at the top of the screen. See “Table 8: TMS Status Symbols” on page 96 for further details on these icons.



- 4 Scroll to the message you want to read by pressing the  button.

Note: If the message fills more than one screen, scroll to read it by pressing  or  button.

- 5 To delete the message, press  below DEL. See “Delete a Message” on page 104 for further details.

Compose a New Text Message

- 1 Press  below COMP to compose a new message.

The Compose Message Screen appears.

LIST or NEW option appears on the display.

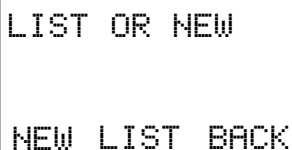

LIST OR NEW
NEW LIST BACK

- 2 Press  below NEW to type a new message.

A blinking cursor appears on the display indicating point of input.



! ADDR SAVE BACK

3 Writing Text

Type your message using the keypad.

Press the key labeled with the desired character, once for the first character, twice for the second, and so on.

For example:

To enter "s", press  key four times. To enter "7", press the key five times. If you do not press a key for a few seconds, the character is accepted, and the cursor moves to the next position.

Press  key to delete a character.

You can move the cursor by pressing  or .

Press and hold 0 to toggle between normal text entry mode, uppercase mode and num lock mode.

Note: i) During the uppercase mode, multi-tapping the keys will only scroll through the uppercase letters.

(Example: A->B->C->2)

ii) During the num lock mode, pressing the keypad will only enter the numeric digits. Subsequent presses of the same key will insert the same digit to the text message (no multi-tap).

Table 9: Keypad Characters



Key	Number of times the key is pressed (in normal mode)								
	1	2	3	4	5	6	7	8	9
0	0 or press and hold to toggle between normal text entry mode, uppercase mode and num lock mode.								
1	1 . , ? ! ; @ _ - * # & \$ / + = \ " ' ()								
2 abc	a	b	c	2	A	B	C		
3 def	d	e	f	3	D	E	F		
4 ghi	g	h	i	4	G	H	I		
5 jkl	j	k	l	5	J	K	L		
6 mno	m	n	o	6	M	N	O		
7 pqrs	p	q	r	s	7	P	Q	R	S
8 tuv	t	u	v	8	T	U	V		
9 wxyz	w	x	y	z	9	W	X	Y	Z
*	Space								
#	Delete a character								

4 Addressing a Message

Press  below ADDR to address your outgoing message.

The Address input screen appears.



Press  or  to scroll through the address list.

OR

Use direct address entry via multi-tap.

5 Append a Priority Message or Request Reply

Before sending your message, you can append a priority message or a request reply to your message.

Press  below IMPT to toggle on/off a “Priority” flag for an outgoing message. A “Priority” flag icon is displayed at the top of the screen when it is toggled on. See “Table 8: TMS Status Symbols” on page 96.

Press  below RGRP to toggle on/off the “Request Reply” icon for an outgoing message. A “Request Reply” status icon is displayed at the top of the screen when it is toggled on. See “Table 8: TMS Status Symbols” on page 96.



Note: When you receive a message on the XTS 2500 radio that is flagged with the “Request Reply” icon, you must manually respond to the sender that you have received the message. The system will not automatically send back a notification that the radio received such message.

Note: The “Priority” flag on a message does not imply that the message will get higher priority over the other messages when it is being transmitted. It is just an indication that can be embedded into a message to let the receiver know that the message is important.

- 6** When an address has been appended to the outgoing message, press the **PTT** button to send your message.

OR

Press  below **SAVE** to save your message for sending at a later time.

The message will be saved in the “Draft folder”. See “To Access the Draft Folder” on page 105 for further details.

Send a Predefined Message

The Quick Text Messages are messages that are predefined and usually consist of messages that are used most frequently.

- 1** Press  below **LIST** to use the predefined message

OR

Press on the preprogrammed Quick Text button.

The first predefined message appears.

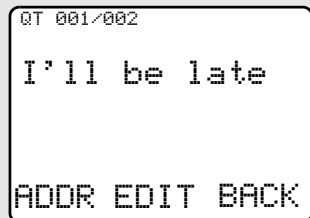

Note: Any programmable button on the radio can be programmed to access the Quick Text Messages feature.

See “Programmable Features” on page 4 for more information on buttons that are programmable to access Quick Text Messages.

- 2 When a message has been selected from the list, address your message and press the PTT button to send the message.

Edit a Quick Text Message

- 1 Press  below EDIT to edit a quick text message.
The Editing Screen appears. A blinking cursor appears at the end of the predefined text.

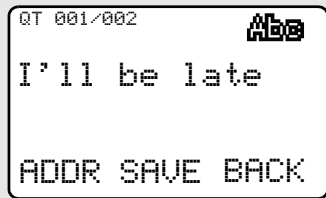

Edit your message using the keypad.

- 2 Press  below SAVE to save the edited changes. The message is saved in the Draft folder.
- 3 When an address has been appended to the outgoing message, press the PTT button to send the edited message.

Reply to a Received Message

- 1 Press  below RPLY to reply to a message.

The Compose Message Screen appears.

LIST or NEW option appears on the display.



LIST OR NEW

NEW LIST BACK

- 2 Press  below NEW to type a new message.

OR

Press  below LIST to use the predefined message / quick text message.

Delete a Message

- 1 From the Inbox, Draft or Sent screen, scroll to select a message for deletion.

- 2 After selecting a message, press  below DEL. The display shows 2 delete options.

Press  below CURR to delete only the current message.



INBOX 001/002

FROM: User228
Hello

CURR ALL BACK

OR

Press  below ALL to delete all messages.

- 3 When you select to delete all messages, a confirmation screen appears.

Press  below YES to delete all messages.

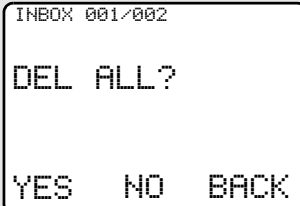

INBOX 001/002
DEL ALL?
YES NO BACK

To Access the Draft Folder



The Draft folder stores the messages that were saved previously. The Draft folder can hold up to 10 messages. The oldest draft in the folder is deleted when the 11th message comes in.

- 1 Press  below DRFT. The Draft screen appears.

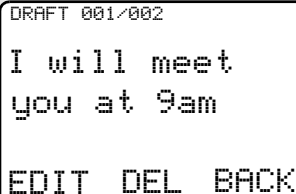
The first draft in the list is displayed.



DRAFT 001/002
I will meet
you at 9am
EDIT DEL BACK



- 2 Press  or  to scroll through the list of drafts.

To Access the Sent Folder

The Sent folder stores the messages that were sent out previously. The Sent folder can hold up to 10 messages. The oldest Sent message in the folder is deleted when the 11th message comes in.

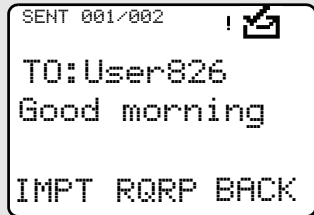
- 1 Press  below SENT. The Sent screen appears. The first sent message in the list is displayed. A message delivery icon will be displayed at the top right corner of the screen. See “Table 8: TMS Status Symbols” on page 96 for more details.



- 2 Press  or  to scroll through the list of other messages that have been sent.
-

Helpful Tips

Radio Care

Cleaning

To clean the external surfaces of your radio:

- 1 Combine one teaspoon of mild dishwashing detergent to one gallon of water (0.5% solution).
- 2 Apply the solution sparingly with a stiff, non-metallic, short-bristled brush, making sure excess detergent does not get entrapped near the connectors, controls or crevices. Dry the radio thoroughly with a soft, lint-free cloth.
- 3 Clean battery contacts with a lint-free cloth to remove dirt or grease.



Caution

Do not use solvents to clean your radio. Spirits may permanently damage the radio housing.

Do not submerge the radio in the detergent solution.

Handling

- Do not pound, drop, or throw the radio. Never carry the radio by the antenna.
- Avoid subjecting the radio to an excess of liquids.
- Avoid subjecting the radio to corrosives, solvents or spirits.
- Do not disassemble the radio.
- Keep the accessory-connector cover in place until ready to use the connector. Replace the cover immediately once the accessory has been disconnected.

Service

Proper repair and maintenance procedures will assure efficient operation and long life for this product. A Motorola maintenance agreement will provide expert service to keep this and all other communication equipment in perfect operating condition. A nationwide service organization is provided by Motorola to support

maintenance services. Through its maintenance and installation program, Motorola makes available the finest service to those desiring reliable, continuous communications on a contract basis. For a contract service agreement, please contact your nearest Motorola service or sales representative, or an authorized Motorola dealer.

Express Service Plus (ESP) is an optional extended service coverage plan, which provides for the repair of this product for a period of three years from the date of shipment from the factory, or the date of delivery if purchased from an authorized Motorola two-way radio dealer. For more information about ESP, contact the Motorola Radio Support Center, 2204 Galvin Drive, Elgin, IL 60123, 1-800-227-6772.

Battery

Battery Life

Battery life is determined by several factors. Among the more critical are the regular overcharge of batteries and the average depth of discharge with each cycle. Typically, the greater the overcharge and the deeper the average discharge, the fewer cycles a battery will last. For example, a battery which is overcharged and discharges 100% several times a day, will last fewer cycles than a battery that receives less of an overcharge and is discharged to 50% per day. Further, a battery which receives minimal overcharging and averages only 25% discharge, will last even longer.

Charging the Battery

Motorola batteries are designed specifically to be used with a Motorola charger and vice-versa. Charging in non-Motorola equipment may lead to battery damage and void the battery warranty. Motorola-authorized battery chargers may not charge batteries other than the ones listed on page 114.

The battery should be at about 77°F (25°C) (room temperature), whenever possible. Charging a cold battery (below 50° F [10°C]) may result in leakage of electrolyte and ultimately in failure of the battery. Charging a hot battery (above 95°F [35°C]) results in reduced discharge capacity, affecting the performance of the radio. Motorola

rapid-rate battery chargers contain a temperature-sensing circuit to ensure that batteries are charged within the temperature limits stated above.

Battery Charge Status

Your radio can indicate your battery's charge status by the following:

LED and Sounds

- you see the LED blinks red when the PTT Button is pressed indicating low battery
- you hear a low-battery “chirp” (short, high-pitched tone)





Conventional Fuel Gauge Symbol

A blinking fuel gauge symbol () is displayed only when the battery voltage drops to low level. In this case, replace the battery with a fully charged one.

Smart Fuel Gauge Symbol

Note: Smart battery will be available at a future date.

Consult the Smart Battery manual. All conditions must be met for a battery to be classified as a “Smart Battery.” When your radio has a Smart Battery installed, the fuel gauge symbol is always displayed.

Gauge shows:	if the battery's charge is:
	71% to 100% full
	41% to 70%
	11% to 40%
	10% or less (at 10%, the gauge begins blinking)

Replace the battery with a fully charged one when the fuel gauge shows the lowest level.

Battery Recycling and Disposal

Nickel-cadmium (NiCd) rechargeable batteries can be recycled. However, recycling facilities may not be available in all areas. Under various U.S. state laws and the laws of several other countries, NiCd batteries must be recycled and cannot be disposed of in landfills or incinerators. Contact your local waste management agency for specific requirements and information in your area.

Motorola fully endorses and encourages the recycling of NiCd batteries. In the U.S. and Canada, Motorola participates in the nationwide Rechargeable Battery Recycling Corporation (RBRC) program for NiCd battery collection and recycling. Many retailers and dealers participate in this program.

For the location of the drop-off facility closest to you, access RBRC's Internet web site at www.rbrc.com or call 1-800-8-BATTERY. This internet site and telephone number also provide other useful information concerning recycling options for consumers, businesses, and governmental agencies.

Antenna

Radio Operating Frequencies

Before installing the antenna, make sure it matches your radio's operating frequency. Antennas are frequency sensitive and are color coded according to their frequency range. The color code indicator is located in the center of the antenna's base.

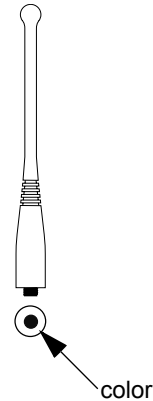

The following antenna types are compatible with your radio:

Antenna Type	Approx. Length		Insulator Color Code	Frequency Range (MHz)	Antenna Kit No.
	in.	mm			
VHF whip	8	203	RED	136–174	NAD6563
VHF helical	7.6	193	YELLOW	136–150.8	NAD6566
VHF helical	7	178	BLACK	150.8–162	NAD6567
VHF helical	6.5	165	BLUE	162–174	NAD6568
UHF helical	3.3	83	RED	380–435	NAE6546
UHF helical	3.1	78	GREEN	435–470	NAE6547
UHF helical	2.8	71	BLACK	470–520	NAE6548
UHF whip, wideband	5.2	133	GRAY	380–520	NAE6549

Helpful Tips

Antenna Type	Approx. Length		Insulator Color Code	Frequency Range (MHz)	Antenna Kit No.
	in.	mm			
800 MHz whip, halfwave	7	178	RED	806–870	NAF5037
800 MHz dipole	8	200	RED	806–870	NAF5039
900MHz whip, halfwave	6.7	169	BLUE	896 – 941	NAF5038
900MHz dipole	8	201	BLUE	896 – 941	NAF5040
800/900 MHz stubby, quarterwave	3.4	85	WHITE	806–941	NAF5042
700/800 MHz whip	7	178	GREEN	764–870	NAF5080

Accessories

Motorola provides the following approved accessories to improve the productivity of your XTS 2500 / XTS 2500I portable two-way radio.

For a list of Motorola-approved antennas, batteries, and other accessories, visit the following web site which lists approved accessories: <http://www.motorola.com/governmentandenterprise>

Antennas

NAD6563	VHF whip (136–174 MHz)
NAD6566	VHF (136–150.8 MHz)
NAD6567	VHF (150.8–162 MHz)
NAD6568	VHF (162–174 MHz)
NAE6546	UHF (380–435 MHz)
NAE6547	UHF (435–470 MHz)
NAE6548	UHF (470–520 MHz)
NAE6549	UHF whip (380–520 MHz)
NAF5037	800 MHz whip, halfwave (806–870 MHz)
NAF5038	900 MHz whip, halfwave (896 – 941 MHz)
NAF5039	800 MHz dipole (806–870 MHz)
NAF5040	900 MHz dipole (896–941 MHz)
NAF5042	800/900 MHz stubby, quarterwave (806–941 MHz)
NAF5080	700/800 MHz whip (764–870 MHz)

Batteries

NTN9815	NiCd high-capacity
NTN9816	NiCd high-capacity, Factory Mutual Intrinsically Safe
*NTN9857	NiMH ultra-high-capacity, Factory Mutual Intrinsically Safe, IMPRES
*NTN9858	NiMH ultra-high-capacity, IMPRES
*NNTN6263	JedRay NiMH FM, Battery Immersible, IMPRES

* Batteries include an over-discharge protection circuit (similar to those in Li-Ion batteries) to extend life of batteries by preventing excessive battery discharge during customer use. Motorola strongly recommends charging these batteries with Motorola-approved IMPRES desktop charges programmed with version 3.4 of the IMPRES desktop charger software.

Carry Accessories

Belt Clips

HLN6853	Belt clip, 2 1/4 inch
---------	-----------------------

Body-Worn

NNTN4115	Carrying case, leather with 3-in. swivel belt loop and T-strap
NNTN4116	Carrying case, leather with 2.5-in. swivel belt loop and T-strap
NNTN4117	Carrying case, leather with 3-in. belt loop and T-strap
NLN6349	Shoulder strap for carrying radio
NTN5243	Shoulder strap for carrying radio
TDN9675	Wrist strap for carrying radio

Chargers

NLN7967	Wall-mount kit for multi-unit charger
NLN7968	Rack-mount kit for multi-unit charger
NTN1168	Single-unit dual rate, rapid charger 120V
NTN1169	Single-unit dual rate, rapid charger 220V (2-prong Euro plug)
NTN1170	Single-unit dual rate, rapid charger 240V (3-prong UK plug)
NTN1177	Multi-unit, dual rate, rapid charger 110V
NTN1178	Multi-unit, dual rate, rapid charger 240V (3-prong UK plug)
NTN1179	Multi-unit, rapid charger 240V (UK 13 MAP Plug)
NTN1667	Tri-chemistry, 110V
NTN1668	Tri-Chemistry, 220V Single Unit Charger (2 Prong Euro Plug)
NTN1669	Tri-chemistry, 230V
NTN1873	IMPRES™ rapid charger 110V single-unit
NTN1874	IMPRES™ rapid charger 220V single-unit
NTN1875	IMPRES™ rapid charger 240V single-unit
NTN4796	Multi-unit, tri-chemistry, rapid rate, 110V
NTN7209	Single-unit dual rate, rapid charger w/o cord
RLN4884	Single-unit Travel Charger

Enhanced and Multi-Unit Line Cords

NTN7373	110V interchangeable line
NTN7374	220V interchangeable line (2-prong Euro plug)
NTN7375	240V interchangeable line (3-prong UK plug)

Microphones, Remote Speaker

HMN4080	GPS SMART/ Submersible RSM
HMN4084	Speaker mic Non-Submersible / GPS RSM
NMN6191	Remote speaker mic, noise-canceling (includes 6.0-ft coiled cord assembly, 3.5-mm earjack, swivel clip, quick disconnect)
NMN6193	Remote speaker mic
NNTN4285	Remote speaker mic adapter
ZMN6031	Speaker mic, 3-piece
ZMN6032	Speaker mic, 2-piece
ZMN6038	Speaker mic, 2-piece, extra loud
ZMN6039	Speaker mic, 3-piece, extra loud
*RMN5074	18 inch Public Safety Microphone
*RMN5073	24 inch Public Safety Microphone
*RMN5072	30 inch Public Safety Microphone

Note: Accessories *RMN5074, *RMN5073 and *RMN5072 are not to be used with VHF band radios. For 900MHz band radios, use these accessories only with antenna NAF5042.

Surveillance Accessories

Adapters and Adapter Cable

BDN6673	Headset adapter cable (for use with BDN6635 and BDN6645)
BDN6676	Jedi adapter
NTN8613	Surveillance accessory adapter

CommPort[®] Integrated Microphone/Receivers

NTN1624	CommPort with palm PTT
NTN1625	CommPort ear mic with PTT for noise levels up to 100 dB (requires BDN6676 adapter)
NTN1663	CommPort ear mic with ring PTT for noise levels up to 100 dB (requires BDN6676 adapter)
NTN1736	CommPort ear mic with snap-on side PTT for noise levels up to 100 dB (requires BDN6676 adapter)

Earpieces

BDN6641	Ear mic, high noise level up to 105 dB, grey (must order BDN6671 interface module)
BDN6664	Earpiece with standard earphone, beige
BDN6665	Earpiece with extra-loud earphone (exceeds OSHA limits), beige
BDN6666	Earpiece with volume control, beige
BDN6667	Earpiece, mic and PTT combined, beige
BDN6668	Earpiece, mic and PTT separate, beige
BDN6669	Earpiece, mic and PTT combined, with extra-loud earphone (exceeds OSHA limits), beige

Accessories

BDN6670	Earpiece, mic and PTT separate with extra-loud earphone (exceeds OSHA limits), beige
BDN6677	Ear mic, standard, noise up to 95 dB (must order BDN6671 interface module), black
BDN6678	Ear mic, standard, noise up to 95 dB (must order BDN6671 interface module), beige
BDN6719	Earpad, with 3.5mm threaded plug
BDN6726	Earpiece with standard earphone, black
BDN6727	Earpiece with extra-loud earphone (exceeds OSHA limits), black
BDN6728	Earpiece with volume control, black
BDN6729	Earpiece, mic and PTT combined, black
BDN6730	Earpiece, mic and PTT separate, black
BDN6731	Earpiece, mic and PTT combined, with extra-loud earphone (exceeds OSHA limits), black
BDN6732	Earpiece, mic and PTT separate, with extra-loud earphone (exceeds OSHA limits), black
BDN6780	Earbud, single with mic and PTT combined, beige
BDN6781	Earbud, single, receive only, black

Headsets and Headset Accessories

BDN6635	Heavy-duty VOX headset with noise-canceling boom mic (requires BDN6673 adapter)
BDN6636	Heavy-duty VOX headset with throat mic (requires BDN6673)
BDN6645	Noise-canceling boom mic headset with PTT on earcup
NMN1020	Safety helmet headset (requires BDN6676 adapter)
NMN6245	Light-weight headset
NMN6246	Ultralite headset with boom mic
NMN6258	Over-the-head headset with in-line PTT
NMN6259	Medium-weight, dual headset with NC mic
RMN4049	Jedi “TEMCO” temple transducer

Radio Interface Modules for Ear Microphones

BDN6671	Push-to-talk (PTT) and voice-activated (VOX) interface module (for use with BDN6641, BDN6677 and BDN6678)
BDN6708	PTT interface module (for use with BDN6641, BDN6677 and BDN6678)

Switches

0180300E83	Remote PTT body switch
NTN7660	Tilt / man down switch

Notes

Appendix: Maritime Radio Use in the VHF Frequency Range

Special Channel Assignments

Emergency Channel

If you are in imminent and grave danger at sea and require emergency assistance, use **VHF Channel 16** to send a distress call to nearby vessels and the United States Coast Guard. Transmit the following information, in this order:

- 1 "MAYDAY, MAYDAY, MAYDAY."
- 2 "THIS IS _____, CALL SIGN _____."
State the name of the vessel in distress 3 times, followed by the call sign or other identification of the vessel, stated 3 times.
- 3 Repeat "MAYDAY" and the name of the vessel.
- 4 "WE ARE LOCATED AT _____."
State the position of the vessel in distress, using any information that will help responders to locate you, e.g.:
 - latitude and longitude
 - bearing (state whether you are using true or magnetic north)
 - distance to a well-known landmark
 - vessel course, speed or destination
- 5 State the nature of the distress.
- 6 Specify what kind of assistance you need.
- 7 State the number of persons on board and the number needing medical attention, if any.
- 8 Mention any other information that would be helpful to responders, such as type of vessel, vessel length and/or tonnage, hull color, etc.
- 9 "OVER."
- 10 Wait for a response.
- 11 If you do not receive an immediate response, remain by the radio and repeat the transmission at intervals until you receive a response. Be prepared to follow any instructions given to you.

Non-Commercial Call Channel

For non-commercial transmissions, such as fishing reports, rendezvous arrangements, repair scheduling, or berthing information, use **VHF Channel 9**.

Operating Frequency Requirements

A radio designated for shipboard use must comply with Federal Communications Commission Rule Part 80 as follows:

- on ships subject to Part II of Title III of the Communications Act, the radio must be capable of operating on the 156.800 MHz frequency.
- on ships subject to the Safety Convention, the radio must be capable of operating:
 - in the simplex mode on the ship station transmitting frequencies specified in the 156.025–157.425 MHz frequency band, and
 - in the semiduplex mode on the two frequency channels specified in the table below.

Note: Simplex channels 3, 21, 23, 61, 64, 81, 82, and 83 **cannot be lawfully used** by the general public in US waters.

Additional information about operating requirements in the Maritime Services can be obtained from the full text of FCC Rule Part 80 and from the US Coast Guard.

Table A-1: VHF Marine Channel List

Channel Number	Frequency (MHz)	
	Transmit	Receive
1	156.050	160.650
2	156.100	160.700
*	156.150	160.750
4	156.200	160.800
5	156.250	160.850
6	156.300	–
7	156.350	160.950

Table A-1: VHF Marine Channel List (Continued)

Channel Number	Frequency (MHz)	
	Transmit	Receive
8	156.400	–
9	156.450	156.450
10	156.500	156.500
11	156.550	156.550
12	156.600	156.600
13**	156.650	156.650
14	156.700	156.700
15**	156.750	156.750
16	156.800	156.800
17**	156.850	156.850
18	156.900	161.500
19	156.950	161.550
20	157.000	161.600
*	157.050	161.650
22	157.100	161.700
*	157.150	161.750
24	157.200	161.800
25	157.250	161.850
26	157.300	161.900
27	157.350	161.950
28	157.400	162.000
60	156.025	160.625
*	156.075	160.675
62	156.125	160.725
63	156.175	160.775
*	156.225	160.825
65	156.275	160.875
66	156.325	160.925

Table A-1: VHF Marine Channel List (Continued)

Channel Number	Frequency (MHz)	
	Transmit	Receive
67**	156.375	156.375
68	156.425	156.425
69	156.475	156.475
71	156.575	156.575
72	156.625	–
73	156.675	156.675
74	156.725	156.725
75	***	***
76	***	***
77**	156.875	–
78	156.925	161.525
79	156.975	161.575
80	157.025	161.625
*	157.075	161.675
*	157.125	161.725
*	157.175	161.775
84	157.225	161.825
85	157.275	161.875
86	157.325	161.925
87	157.375	161.975
88	157.425	162.025

* Simplex channels 3, 21, 23, 61, 64, 81, 82, and 83 **cannot be lawfully used** by the general public in US waters.

** Low power (1 W) only



*** Guard band

Note: A – in the Receive column indicates that the channel is transmit only.

Glossary

This is a list of specialized terms used in this manual.

ACK	Acknowledgment of communication.
Active Channel	A channel that has traffic on it.
Analog Signal	An RF signal that has a continuous nature rather than a pulsed or discrete nature.
ASTRO 25 Trunking	Motorola standard for wireless digital trunked communications.
ASTRO Conventional	Motorola standard for wireless analog or digital conventional communications.
Call Alert	Privately page an individual by sending an audible tone.
Carrier Squelch	Feature that responds to the presence of an RF carrier by opening or unmuting (turning on) a receiver's audio circuit. A squelch circuit silences the radio when no signal is being received so that the user does not have to listen to noise.
Central Controller	A software controlled, computer-driven device that receives and generates data for the trunked radios assigned to it. It monitors and directs the operations of the trunked repeaters.
Channel	A group of characteristics such as transmit/receive frequency pairs, radio parameters, and encryption encoding.
Control Channel	In a trunking system, one of the channels that is used to provide a continuous, two-way/data communications path between the central controller and all radios on the system.
Conventional	Typically refers to radio-to-radio communications, sometimes through a repeater. (See Trunking.)

Cursor	A visual tracking marker (a blinking line) that indicates a location on the display.
Deadlock	Displayed by the radio after three failed attempts to unlock the radio. The radio must be powered off and on prior to another attempt.
Digital Private Line (DPL)	A type of coded squelch using data bursts. Similar to PL except a digital code is used instead of a tone.
Digital Signal	An RF signal that has a pulsed, or discrete nature, rather than a continuous nature.
Dispatcher	An individual who has radio system management duties.
Dynamic Regrouping	A feature that allows the dispatcher to temporarily reassign selected radios to a single special channel so they can communicate with each other.
Failsoft	A feature that allows communications to take place even though the central controller has failed. Each trunked repeater in the system will transmit a data word informing every radio that the system has gone into failsoft.
FCC	Federal Communications Commission.
Hang Up	Disconnect.
Home Display	The first display information after the radio completes its self test.
LCD	Liquid Crystal Display.
LED	Light-emitting diode.
Menu Entry	A software-activated feature shown at the bottom of the display — selection of these features is controlled by the  ,  , and  buttons.

Monitor	Check channel activity by pressing the Monitor button. If the channel is clear, you will hear static. If the channel is in use, you will hear conversation. It also serves as a way to check the volume level of the radio, as the radio will “open the squelch” when pressing the monitor button.
Network Access Code	Network Access Code (NAC) operates on digital channels to reduce voice channel interference between adjacent systems and sites.
NiCd	Nickel Cadmium.
NiMH	Nickel Metal Hydride.
Non-tactical/Revert	The user will talk on a preprogrammed emergency channel. The emergency alarm is sent on this same channel.
Page	A one-way alert, with audio and/or display messages.
Personality	A set of unique features specific to a radio.
PIN	Personal Identification Number.
Preprogrammed	A feature that has been assigned in advance by a qualified technician.
Private (Conversation) Call	Allows you to have a private conversation with another radio user in the group.
Private Line (PL)	A sub-audible tone that is transmitted such that only receivers decoding this tone will hear the message.
Programmable	A radio control that can have a radio feature assigned to it.
PTT	Push-To-Talk — the PTT button engages the transmitter and puts the radio in transmit (send) operation when pressed.

Radio Frequency (RF)	The part of the general frequency spectrum between the audio and infrared light regions (about 10 kHz to 10,000,000 MHz).
Repeater	A conventional radio feature, where you talk through a receive/transmit facility (repeater), that re-transmits received signals in order to improve communications range and coverage.
Selective Switch	Any digital P25 traffic having the correct Network Access Code and the correct talkgroup.
Squelch	Special electronic circuitry added to the receiver of a radio which reduces, or squelches, unwanted signals before they are heard in the speaker.
Standby	An operating condition whereby the radio's speaker is muted but still continues to receive data.
Tactical/Non-revert	The user will talk on the channel that was selected before the radio entered the emergency state.
Talkaround	Bypass a repeater and talk directly to another unit for easy local unit-to-unit communications.
Talkgroup	An organization of radio users who communicate with each other.
TMS	Text Messaging Service.
Trunking	The automatic sharing of communications paths between a large number of users. (See Conventional.)
Zone	A grouping of channels.

Commercial Warranty

Limited Warranty

MOTOROLA COMMUNICATION PRODUCTS

I. WHAT THIS WARRANTY COVERS AND FOR HOW LONG:

MOTOROLA INC. (“MOTOROLA”) warrants the MOTOROLA manufactured Communication Products listed below (“Product”) against defects in material and workmanship under normal use and service for a period of time from the date of purchase as scheduled below:

ASTRO XTS 2500 / XTS 2500I Portable Units	One (1) Year
Product Accessories	One (1) Year

Motorola, at its option, will at no charge either repair the Product (with new or reconditioned parts), replace it (with a new or reconditioned Product), or refund the purchase price of the Product during the warranty period provided it is returned in accordance with the terms of this warranty. Replaced parts or boards are warranted for the balance of the original applicable warranty period. All replaced parts of Product shall become the property of MOTOROLA.

This express limited warranty is extended by MOTOROLA to the original end user purchaser only and is not assignable or transferable to any other party. This is the complete warranty for the Product manufactured by MOTOROLA. MOTOROLA assumes no obligations or liability for additions or modifications to this warranty unless made in writing and signed by an officer of MOTOROLA. Unless made in a separate agreement between MOTOROLA and the original end user purchaser, MOTOROLA does not warrant the installation, maintenance or service of the Product.

MOTOROLA cannot be responsible in any way for any ancillary equipment not furnished by MOTOROLA which is attached to or used in connection with the Product, or for operation of the Product with any ancillary equipment, and all such equipment is expressly excluded from this warranty. Because each system which may use

the Product is unique, MOTOROLA disclaims liability for range, coverage, or operation of the system as a whole under this warranty.

II. GENERAL PROVISIONS:

This warranty sets forth the full extent of MOTOROLA'S responsibilities regarding the Product. Repair, replacement or refund of the purchase price, at MOTOROLA's option, is the exclusive remedy. THIS WARRANTY IS GIVEN IN LIEU OF ALL OTHER EXPRESS WARRANTIES. IMPLIED WARRANTIES, INCLUDING WITHOUT LIMITATION, IMPLIED WARRANTIES OF MERCHANTABILITY AND FITNESS FOR A PARTICULAR PURPOSE, ARE LIMITED TO THE DURATION OF THIS LIMITED WARRANTY. IN NO EVENT SHALL MOTOROLA BE LIABLE FOR DAMAGES IN EXCESS OF THE PURCHASE PRICE OF THE PRODUCT, FOR ANY LOSS OF USE, LOSS OF TIME, INCONVENIENCE, COMMERCIAL LOSS, LOST PROFITS OR SAVINGS OR OTHER INCIDENTAL, SPECIAL OR CONSEQUENTIAL DAMAGES ARISING OUT OF THE USE OR INABILITY TO USE SUCH PRODUCT, TO THE FULL EXTENT SUCH MAY BE DISCLAIMED BY LAW.

III. STATE LAW RIGHTS:

SOME STATES DO NOT ALLOW THE EXCLUSION OR LIMITATION OF INCIDENTAL OR CONSEQUENTIAL DAMAGES OR LIMITATION ON HOW LONG AN IMPLIED WARRANTY LASTS, SO THE ABOVE LIMITATION OR EXCLUSIONS MAY NOT APPLY.

This warranty gives specific legal rights, and there may be other rights which may vary from state to state.

IV. HOW TO GET WARRANTY SERVICE:

You must provide proof of purchase (bearing the date of purchase and Product item serial number) in order to receive warranty service and, also, deliver or send the Product item, transportation and insurance prepaid, to an authorized warranty service location. Warranty service will be provided by Motorola through one of its authorized warranty service locations. If you first contact the company

which sold you the Product, it can facilitate your obtaining warranty service. You can also call Motorola at 1-888-567-7347 US/Canada.

V. WHAT THIS WARRANTY DOES NOT COVER:

- A) Defects or damage resulting from use of the Product in other than its normal and customary manner.
- B) Defects or damage from misuse, accident, water, or neglect.
- C) Defects or damage from improper testing, operation, maintenance, installation, alteration, modification, or adjustment.
- D) Breakage or damage to antennas unless caused directly by defects in material workmanship.
- E) A Product subjected to unauthorized Product modifications, disassemblies or repairs (including, without limitation, the addition to the Product of non-Motorola supplied equipment) which adversely affect performance of the Product or interfere with Motorola's normal warranty inspection and testing of the Product to verify any warranty claim.
- F) Product which has had the serial number removed or made illegible.
- G) Rechargeable batteries if:
 - any of the seals on the battery enclosure of cells are broken or show evidence of tampering.
 - the damage or defect is caused by charging or using the battery in equipment or service other than the Product for which it is specified.
- H) Freight costs to the repair depot.
- I) A Product which, due to illegal or unauthorized alteration of the software/firmware in the Product, does not function in accordance with MOTOROLA's published specifications or the FCC type acceptance labeling in effect for the Product at

the time the Product was initially distributed from MOTOROLA.

- J) Scratches or other cosmetic damage to Product surfaces that does not affect the operation of the Product.
- K) Normal and customary wear and tear.

VI. PATENT AND SOFTWARE PROVISIONS:

MOTOROLA will defend, at its own expense, any suit brought against the end user purchaser to the extent that it is based on a claim that the Product or parts infringe a United States patent, and MOTOROLA will pay those costs and damages finally awarded against the end user purchaser in any such suit which are attributable to any such claim, but such defense and payments are conditioned on the following:

- A) that MOTOROLA will be notified promptly in writing by such purchaser of any notice of such claim;
- B) that MOTOROLA will have sole control of the defense of such suit and all negotiations for its settlement or compromise; and
- C) should the Product or parts become, or in MOTOROLA's opinion be likely to become, the subject of a claim of infringement of a United States patent, that such purchaser will permit MOTOROLA, at its option and expense, either to procure for such purchaser the right to continue using the Product or parts or to replace or modify the same so that it becomes non-infringing or to grant such purchaser a credit for the Product or parts as depreciated and accept its return. The depreciation will be an equal amount per year over the lifetime of the Product or parts as established by MOTOROLA.

MOTOROLA will have no liability with respect to any claim of patent infringement which is based upon the combination of the Product or parts furnished hereunder with software, apparatus or devices not furnished by MOTOROLA, nor will MOTOROLA have any liability for

the use of ancillary equipment or software not furnished by MOTOROLA which is attached to or used in connection with the Product. The foregoing states the entire liability of MOTOROLA with respect to infringement of patents by the Product or any parts thereof.

Laws in the United States and other countries preserve for MOTOROLA certain exclusive rights for copyrighted MOTOROLA software such as the exclusive rights to reproduce in copies and distribute copies of such Motorola software. MOTOROLA software may be used in only the Product in which the software was originally embodied and such software in such Product may not be replaced, copied, distributed, modified in any way, or used to produce any derivative thereof. No other use including, without limitation, alteration, modification, reproduction, distribution, or reverse engineering of such MOTOROLA software or exercise of rights in such MOTOROLA software is permitted. No license is granted by implication, estoppel or otherwise under MOTOROLA patent rights or copyrights.

VII. GOVERNING LAW:

This Warranty is governed by the laws of the State of Illinois, USA.

Notes

Index

A

access	
draft folder	105
inbox	98
sent folder	106
TMS feature	
use the menu	93
use the preprogrammed TMS button	94
use TMS feature button	93
user login feature	87
accessories	
antennas	113
batteries	114
belt clips	114
body-worn	114
carry accessories	114
chargers	115
Commport integrated microphone/ receivers	117
earpieces	117
headsets	119
microphones, remote speaker	116
radio interface modules	119
switches	119
alert tones	13
analog squelch	38
answer	
phone call	
use the preprogrammed call response button	55
private call	
use the preprogrammed call response button	59
antenna	20
radio operating frequencies ...	111
antennas	113
App button	10
attach	
adapter	23
antenna	20
battery	18
belt clip	21

universal connector cover	22
---------------------------------	----

B

backlight	5
batteries	114
battery	17
battery charge status	109
charger	17
charging the battery	17
recycling and disposal	110
belt clip	21

C

call alert paging	62
answer a call alert page	62
make a call alert	
use the keypad	64
use the menu	63
carry accessories	
belt clips	114
body-worn	114
change	
ARS mode	85
change passwords	36
charge the battery	17
chargers	115
enhanced and multi-unit line cords 115	
common radio features	35
conventional	
mode operation	34
squelch options	38
talkgroup calls	65
conventional fuel gauge symbol	109

D

delete a message	104
digital squelch	38
display	5
dynamic priority change	54
dynamic regrouping	71

E

- edit
 - call, page, or phone list name
 - use the menu49
 - call, page, or phone list number
 - use the menu47
 - quick text message103
 - time and date78
- edit a list name49
- emergency41
 - keep-alive44
 - send a silent emergency alarm 43
 - send an emergency alarm41
 - send an emergency call42

F

- failsoft74
- four-way navigation button10

G

- general radio operation1
- glossary125

H

- home button10

I

- inbox
 - delete a message104
 - view message98
- individual calls55

K

- keypad11

L

- LED indicators12
- list
 - scan list empty46
 - view a list45
- lists45
- lock or unlock a site
 - use the menu75

- use the preprogrammed site lock/
unlock button 75

M

- make a phone call
 - use the menu 56
 - use the quick access button 56
- make a private call
 - use the menu 60, 62
 - use the quick access
button 60, 62
- menu
 - TMS menu options 95
- menu entry (softkey) 8
- menu select buttons 8
- menu selection features 9
- microphones, remote speaker .. 116
- mode
 - ARS Non server mode 85
 - ARS server mode 85
- mode select button 30
- mute or unmute keypad tones 37
 - use the menu 37
 - using the preprogrammed side
button 37

N

- notations used in this manual 1

O

- out-of-range 74

P

- phone call
 - make
 - use the menu 56
 - use the quick access button 56
- phone call display and alert
 - prompts 58
- physical features of the radio 3
- PIN
 - enter pin 89
- PL defeat 39

-
- predefined
 - message,quick text 102
 - username 92
 - priority
 - priority message 96
 - private call
 - answer
 - use the keypad 61
 - use the preprogrammed call response button 59
 - make
 - use the menu 60, 62
 - use the quick access button 60, 62
 - private data 91
 - programmable features 4
 - PTT ID 67, 69

 - R**
 - radio care
 - cleaning 107
 - handling 107
 - radio kill
 - direct kill 67
 - remote kill 67
 - radio lock
 - change your password 36
 - unlock your radio 35
 - radio stun 68
 - receive a message 98
 - receive and transmit
 - use the preprogrammed monitor button 33
 - without using the volume set and monitor buttons 31
 - remote speaker microphone adapter
 - remove the adapter 23
 - remove
 - antenna 20
 - battery 18
 - belt clip 21
 - remote speaker microphone adapter 23
 - universal connector 22
 - repeater or direct operation 66
 - select repeater or direct 66
 - reply a message 99
 - reprogram request 71
 - use the preprogrammed reprogram request button 72
 - request a new dynamic regrouping using the menu 71

 - S**
 - scan 51
 - delete a nuisance channel 53
 - turn scan on and off 51
 - scan (conventional only)
 - make a dynamic priority change 54
 - scan list empty 46
 - select
 - channel
 - method 2: use the menu 29
 - use the menu CHAN 28
 - enable / disable 73
 - repeater or direct operation
 - use the menu 66, 80
 - talkgroup 65
 - zone
 - use the menu 26
 - use the preprogrammed zone switch 27
 - send
 - emergency alarm 41
 - emergency call 42
 - new text message 99
 - predefined message,quick text message 102
 - silent emergency alarm 43
 - service 107
 - site lock 75
 - site trunking 76
 - site view and change 76
 - smart
 - battery condition

- use the menu19
- use the preprogrammed smart battery button19
- smart fuel gauge symbol109
- standard accessories17
- status
 - TMS status symbols96
- status symbols6
- surveillance accessories117
 - Commport integrated microphone/receivers117
 - earpieces117
 - headsets and headset accessories119
 - radio interface modules for ear microphones119
- switches119

T

- text messaging93
- time and date78
 - edit time and date78
- time-out timer40
- trunking system controls74
- turn the radio off25
- turn the radio on25

U

- universal connector
 - attach the cover22
 - remove the cover22
- user
 - access
 - use the menu item87
 - use the preprogrammed user button87, 102
 - log out91
 - login88
- username
 - direct entry, multi-tap88
 - predefined username89
 - valid characters89

V

- view
 - list45
 - your radio's ID number
 - use the menu70
 - use the preprogrammed call or page button70
- view message98

W

- warranty129
- writing text99

Z

- zones and channels26



MOTOROLA

Motorola, Inc.
1301 E. Algonquin Rd.
Schaumburg, IL60196-1078, USA.

MOTOROLA, the Stylized M Logo, ASTRO,
and SmartZone are registered in the U.S.
Patent & Trademark Office.
All other product or service names are the
property of their respective owners.
© 2007, 2008 by Motorola, Inc.
All rights reserved. Printed in U.S.A.



6816981H01-E